

QC *series*
shallow grooving tools



How to select parting and grooving tools

How to select parting and grooving tools

Structure of parting and grooving tools selection table

- Categorized as external machining, internal machining and profile machining.
- Concluded and separately listed according to product series (Little squirrel series and Supplementary series).

Dimensions

Application of external machining, internal machining and profile machining

External parting, grooving and turning tools

Type	Stock		Basic dimensions(mm)						Applicable inserts	Screw	Wrench		
	R	L	R / B	LF	WF	CW	CDK _{min}						
QEAD	1210RL07	▲	▲	12	112	12	120	12.15	1.5	7	ZD40YH00	GB70-85-M4-12	WH30L
	1210RL12	▲	▲	12	112	12	120	12.15	1.5	12	ZD40YH00	GB70-85-M4-12	WH30L
	1618RL07	▲	▲	16	116	16	120	16.15	1.5	7	ZD40YH00	GB70-85-M4-16	WH40L
	1618RL12	▲	▲	16	116	16	120	16.15	1.5	12	ZD40YH00	GB70-85-M4-16	WH40L
	2020RL07	▲	▲	20	200	20	120	20.15	1.5	7	ZD40YH00	GB70-85-M4-20	WH40L
QEED	1210RL07	▲	▲	12	112	12	120	12.2	2	7	Z0R05000	GB70-85-M4-12	WH30L
	1210RL12	▲	▲	12	112	12	120	12.2	2	12	Z0R05000	GB70-85-M4-12	WH30L
	1210RL14	▲	▲	12	112	12	120	12.2	2	14	Z0R05000	GB70-85-M4-12	WH30L
	1618RL07	▲	▲	16	116	16	120	16.2	2	7	Z0R05000	GB70-85-M4-16	WH40L
	1618RL12	▲	▲	16	116	16	120	16.2	2	12	Z0R05000	GB70-85-M4-16	WH40L
	1618RL14	▲	▲	16	116	16	120	16.2	2	14	Z0R05000	GB70-85-M4-16	WH40L
	2020RL07	▲	▲	20	200	20	120	20.2	2	7	Z0R05000	GB70-85-M4-20	WH40L
	2020RL12	▲	▲	20	200	20	120	20.2	2	12	Z0R05000	GB70-85-M4-20	WH40L
	2020RL14	▲	▲	20	200	20	120	20.2	2	14	Z0R05000	GB70-85-M4-20	WH40L
	2020RL16	▲	▲	20	200	20	120	20.2	2	16	Z0R05000	GB70-85-M4-20	WH40L
QEFD	1618RL10	▲	▲	16	116	16	120	16.25	2.5	10	Z0R05000	GB70-85-M4-16	WH40L
	1618RL17	▲	▲	16	116	16	120	16.25	2.5	17	Z0R05000	GB70-85-M4-16	WH40L
	2020RL10	▲	▲	20	200	20	120	20.25	2.5	10	Z0R05000	GB70-85-M4-20	WH40L
	2020RL17	▲	▲	20	200	20	120	20.25	2.5	17	Z0R05000	GB70-85-M4-20	WH40L
	2020RL19	▲	▲	20	200	20	120	20.25	2.5	19	Z0R05000	GB70-85-M4-20	WH40L
QEGD	2020RL13	▲	▲	20	200	20	180	20.4	4	13	Z0R05000	GB70-85-M4-20	WH40L
	2020RL15	▲	▲	20	200	20	180	20.4	4	15	Z0R05000	GB70-85-M4-20	WH40L
	2020RL19	▲	▲	20	200	20	180	20.4	4	19	Z0R05000	GB70-85-M4-20	WH40L

▲ Stock available △ Make-to-order

Specification of products Including type, basic dimensions, applicable inserts and accessories.

Internal grooving and turning tools

Type	Stock		Basic dimensions(mm)						Applicable inserts	Screw	Wrench
	R	L	DCON	LF	WF	CW	CDK _{min}	DMN			
C200-QGDR/L05-27	▲	▲	20	180	15.2	2.8	5	27	ZTE02000	GB70-85-M4-12	WH30L
C25R-QGDR/L07-33	▲	▲	25	200	20.3	3.5	7	33	ZTE02000	GB70-85-M4-16	WH40L
C32S-QGDR/L09-42	▲	▲	32	250	25.3	3.5	9	42	ZTE02000	GB70-85-M4-20	WH40L
C200-QGDR/L05-27	▲	▲	20	180	15.2	3	5	27	ZTF00000	GB70-85-M4-12	WH30L
C25R-QGDR/L07-33	▲	▲	25	200	20.3	3	7	33	ZTF00000	GB70-85-M4-16	WH40L
C32S-QGDR/L09-42	▲	▲	32	250	25.3	3	9	42	ZTF00000	GB70-85-M4-20	WH40L
C25R-QGDR/L11-44	▲	▲	25	200	21.5	4	8	35	ZTK00000	GB70-85-M4-16	WH40L
C32S-QGDR/L11-44	▲	▲	32	250	27.0	4	11	44	ZTK00000	GB70-85-M4-20	WH40L
C40T-QGDR/L13-54	▲	▲	40	300	33.0	4	13	54	ZTK00000	GB70-85-M4-20	WH40L
C25R-QH0R/L08-35	▲	▲	25	200	21.0	5	8	35	ZTH00000	GB70-85-M4-16	WH40L
C32S-QH0R/L11-44	▲	▲	32	250	27.0	5	11	44	ZTH00000	GB70-85-M4-20	WH40L
C40T-QH0R/L13-54	▲	▲	40	300	33.0	5	13	54	ZTH00000	GB70-85-M4-20	WH40L
C25R-QKDR/L08-35	▲	▲	25	200	21.0	6	8	35	ZTK00000	GB70-85-M4-16	WH40L
C32S-QKDR/L11-44	▲	▲	32	250	27.0	6	11	44	ZTK00000	GB70-85-M4-20	WH40L
C40T-QKDR/L13-54	▲	▲	40	300	33.0	6	13	54	ZTK00000	GB70-85-M4-20	WH40L

▲ Stock available △ Make-to-order

Profile turning tools for Al

Type	Stock		Basic dimensions(mm)					Applicable inserts	Screw	Wrench
	R	L	DMN (Minimum machining diameter)	DCON	WF	LF	CDK			
CAEA-GLDR/L05-15A	▲	▲	180	40	21	320	65	ZKL008-LH	GB70-85-M4-20	WH30L
CAEA-GLDR/L08-15A	▲	▲	180	40	21	320	80	ZKL008-LH	GB70-85-M4-20	WH30L
CAEA-QKDR/L05-15A	▲	▲	180	40	20	320	60	ZKAD08-LH	GB70-85-M4-20	WH30L
CAEA-QKDR/L07-15A	▲	▲	180	40	20	320	75	ZKAD08-LH	GB70-85-M4-20	WH30L

▲ Stock available △ Make-to-order

Indicating the minimum machining diameter

The minimum machining diameter is very important for internal machining.



TURNING



Parting and grooving tools



Parting and grooving tools overview ● A230-A232

Parting and grooving inserts ● A233-A253

Introduction of G-series parting and grooving tools ● A233-A234

Introduction of QC series shallow grooving tools ● A235

Introduction of little squirrel series inserts chipbreaker ● A236-A239

Parting, grooving and profiling inserts code key ● A240

Inserts of little squirrel series ● A241-A247

G-series parting and grooving inserts ● A248-A249

QC series shallow grooving inserts code key ● A250

QC series shallow grooving inserts ● A251-A252

Inserts of ZQMX series ● A253

Parting and grooving tools ● A254-A282

Little squirrel series ●

Little squirrel series parting and grooving tools code key ● A254-A255

External parting, grooving and turning tools ● A256-A257

Precise grooving and turning tools ● A257

External recess and profiling tools ● A258

External grooving tools for difficult-to-machine materials ● A258

External parting blade and holder for external parting ● A259

End surface grooving and turning tools ● A260-A265

L type tools for surface grooving and turning ● A266-A267

Internal grooving and turning tools ● A268

Profile turning tools for Al ● A268

G-series parting and grooving tools ●

External parting, grooving and turning tools ● A269

End surface grooving and turning tools ● A270-A275

L type tools for surface grooving and turning ● A276-A277

Internal grooving and turning tools ● A278

QC series shallow grooving tools ●

QC series shallow grooving tools code key ● A279

External shallow grooving tools ● A280

Internal shallow grooving tools ● A280

Supplementary series ●

Supplementary series parting and grooving tools code key ● A281

QZQ external grooving series ● A282













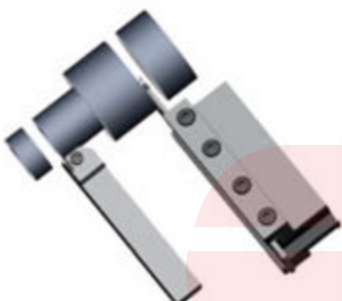



Application information for parting and grooving ● A283-A284













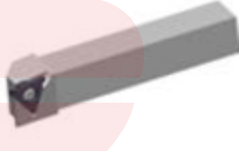

General turning

Parting and grooving

Parting and grooving tools overview

Machining application	Machining type	Applicable tools	Corresponding inserts	Tool features and parameters	
External machining	Parting	<p>Little squirrel series QZ□□+QE□□</p>  <p>A259</p>	<p>Parting inserts ZPOS□□</p> 	<ul style="list-style-type: none"> Assemble structure of parting blade and holder; good rigidity; adjustable parting range. The maximum parting diameter is 120mm. 	
		<p>Little squirrel series QE□□R/L</p>  <p>A256-A257</p>	<p>ZPO□□□</p>  <p>ZPOS□</p> 	<ul style="list-style-type: none"> Inserts have three-dimensional chipbreaker with low cutting force and good performance on chip-breaking. The maximum parting diameter is 60mm. 	
		<p>Supplementary series QZQ□□R/L</p>  <p>A282</p>	<p>ZQMX□□</p> 	<ul style="list-style-type: none"> Cutting edge strength is suitable for bad machining conditions. The maximum parting diameter is 70mm. 	
		<p>G-series GE□□□R/L</p>  <p>A269</p>	<p>Parting inserts G□M□□□□□-GM</p> 	<ul style="list-style-type: none"> The special design of compression screw hole structure is adopted to realize high clamping force; the screw itself can form self-locking to ensure more reliable compression force. High clamping stability to ensure the safety and stability of grooving and transverse turning. Applicable for a variety of grooving and profiling inserts. 	
	Grooving and turning		<p>Little squirrel series QE□□R/L</p>  <p>A256-A257</p>	<p>Double cutting edges for parting ZT□□□□</p>  <p>Profile turning ZR□□□□</p>  <p>Single cutting edge for deep grooving ZT□S□□</p> 	<ul style="list-style-type: none"> A single tool with multiple applications such as grooving, parting and profile turning, reducing tools categories needed. A multifunctional tool when used with grooving inserts. Suitable for profile machining. The maximum slot depth machinable is 30mm.
			<p>G-series GE□□□R/L</p>  <p>A269</p>	<p>Parting inserts G□M□□□□□-GM</p> 	<ul style="list-style-type: none"> Reinforced grooving tools. The special design of compression screw hole structure is adopted to realize high clamping force; the screw itself can form self-locking to ensure more reliable compression force. High clamping stability to ensure the safety and stability of grooving and transverse turning. Applicable for a variety of grooving and profiling inserts.

















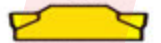
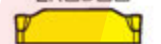

Machining application	Machining type	Applicable tools	Corresponding inserts	Tool features and parameters
External machining	Precise grooving	Little squirrel series QECD  A257	Precise grooving ZT□□□□-EG  Edge width 1.2~2.4mm	<ul style="list-style-type: none"> Grinded insert used for precise grooving. Edge width can be anything between 1.0-6.5mm, customized according to users' needs. ZT□□□□-EG inserts: When edge width is between 1.2-2.4mm, the maximum cutting depth is 2.5mm. When edge width is above 2.4-6.5mm, the maximum cutting depth is 22mm.
		Little squirrel series QE□□R/L  A256-A257	Precise grooving ZT□□□□-EG  Edge width 2.4~6.5mm	
Internal machining	Shallow grooving	QC series GQCR/L  A280	QC16/22□□□□ 	<ul style="list-style-type: none"> Fine grinding of blades with high precision. Sharp edges and high machining accuracy. Three finely ground cutting edges for good economy. For cutting shallow grooves, groove width 0.5-4.8mm. Maximum depth of cut 4mm.
		Little squirrel series C□□-Q□□R/L□  A268	Grooving, Turning ZT□□□□  Profile turning ZR□□□□ 	
Internal machining	Grooving and turning	G-series GID□□R/L  A278	Grooving inserts G□M□□□□□-GM 	<ul style="list-style-type: none"> The minimum machining diameter is 20mm. Maximum depth of cut 11mm. Applicable for a variety of grooving and profiling inserts.
		QC series S□□□-QC□□R/L□  A280	QC11/16/22□□□□ 	

General turning

Parting and grooving

Parting and grooving tools overview

Machining application	Machining type	Applicable tools	Corresponding inserts	Tool features and parameters
End surface machining	Grooving and turning	 <p>G-series GF□□□R/L</p> <p>A274-A275</p>	Grooving inserts G□M□□□□□-GM 	<ul style="list-style-type: none"> Achieve end face machining with a diameter of 28mm. The insert positioning structure is scientifically designed, and the first cutting range is reasonably planned to ensure that the tool body has high strength. High-strength cutter body rounded face for more precise tool selection. Grooving diameter range 28-600mm. Applicable for a variety of grooving and profiling inserts.
		 <p>Little squirrel series QF□□□□□H</p> <p>A262-A265</p>	Grooving, Turning ZT□□□□ Profile turning ZR□□□□  	<ul style="list-style-type: none"> By using inserts for grooving and profiling, one tool can be versatile, reducing the tool categories needed. Grooving diameter is 48-400mm. Grooving depth is 10-30mm.
		 <p>Little squirrel series QF□□□□□L</p> <p>A266-A267</p>	Grooving, Turning ZT□□□□ Profile turning ZR□□□□  	<ul style="list-style-type: none"> 90°holder, top clamping. By using inserts for grooving and profiling, one tool can be versatile, reducing the tool categories needed. Grooving diameter is 48~400mm. Grooving depth is 10~30mm.
Recess machining	Recess machining	 <p>Little squirrel series QX□□□□□□</p> <p>A258</p>	Grooving, Turning ZT□□□□ Profile turning ZR□□□□  	<ul style="list-style-type: none"> The unique tool for recess machining. Complete range of specifications, able to achieve various recess machining.
AI profiling	Inner wall and surface machining	 <p>Little squirrel series C40X□□</p> <p>A268</p>	Little squirrel series ZR□□-LH 	<ul style="list-style-type: none"> The unique tool for profiling of AI material. Cutting edge is designed to combine sharpness and strength, suitable for continuous and intermittent turning. Used for external, surface and inner wall machining of AI wheel hub.
Tools for aviation and aerospace industries	External machining	 <p>Little squirrel series QE□□□□□N</p> <p>A258</p>	Little squirrel series ZIG□□□□  Little squirrel series ZIMF□□ 	<ul style="list-style-type: none"> V-type locating, top clamping, precise locating, safe clamping. Normal square-ended inserts and precise square-ended inserts are suitable for adhesive materials hard to machine such as Ni-base high-temperature alloy, Ti alloy and stainless steel, etc.
	Non-standard Tools	 <p>Non-standard tools to match workpiece</p>	Select and manufacture as required	<ul style="list-style-type: none"> Tailor made solutions for machining various parts to satisfy your requirements.

G-series

high-efficiency parting & grooving inserts

Better clamping stability:

- The new inserts clamping design achieves higher clamping force and better processing;
- Anti-vibration design, excellent surface finish.

High precision inserts:

Edge width 2-4mm, the tolerance of edge width reach $\pm 0.03\text{mm}$;
Edge width 5-6mm, the tolerance of edge width reach $\pm 0.04\text{mm}$;
High consistency of inserts, realizing high-precision machining.

Strengthen the pressing position of the toolholder to ensure the clamping force of the inserts



Wider processing range:



The minimum cutting diameter of the end face can reach $\phi 28\text{mm}$

The minimum processing diameter of the inner hole can reach $\phi 20\text{mm}$

Reinforced structure design of cutter body position

*GIMD / GRMD type inserts can't be installed on little squirrel series parting and grooving holders.

Good chip treatment -GM chipbreaker

Bevel design:

Control chip curled upward and removal.

Raised top:

Ensure the chips curled and broken during processing and inhibit the generation of built-up edge.



The variable rake angle design of the rake face ensures the sharpness and strength of the insert edge.

Curved cutting edge structure design, self-centering processing, can meet various processing conditions such as low and high feed, continuous and intermittent etc., strong versatility.

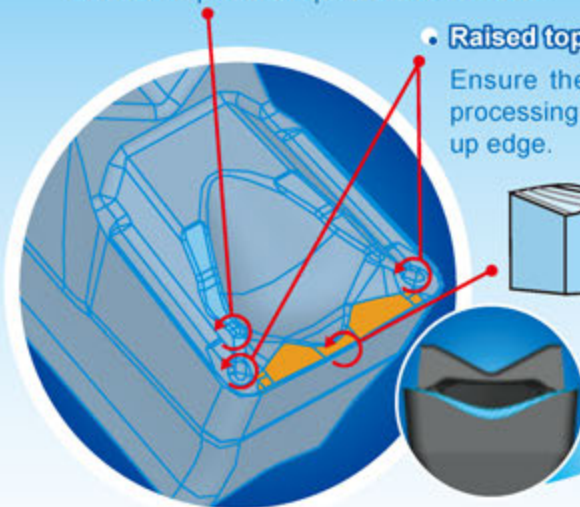

G-series



Supercrystalline Nano Coating

YB9120

Add tough alloy elements to TiAlN coating to obtain high toughness TiAlN-based ceramic coating; Achieve synergistic improvement of coating wear resistance, toughness and high-temperature service performance, grooving and parting PVD coating grades, can meet the processing requirements of P, M, K materials such as parting, grooving, profiling, etc., to achieve long life and safety efficient processing.



YBC103

GRO

A new generation of CVD-coated grades, comprehensively improved the performance of insert edge strength, wear resistance and high temperature oxidation resistance, suitable for efficient processing of various steel materials.

Application case

● Chip curled stably:

Machined material: Stainless steel/45#
Cutting parameters: $V_c = 150\text{m/min}$, $f = 0.15\text{mm/r}$
Inserts: GTMD304-GM/YB9120



Under the same working conditions, our company's GTMD series grooving inserts have better chip breaking performance, which can reduce the downtime for chip removal.

● Excellent performance on machining:

Machined material: Cast iron
Cutting parameters: $V_c = 180\text{m/min}$, $f = 0.15\text{mm/r}$
Inserts: GTMD304-GM/YBC103

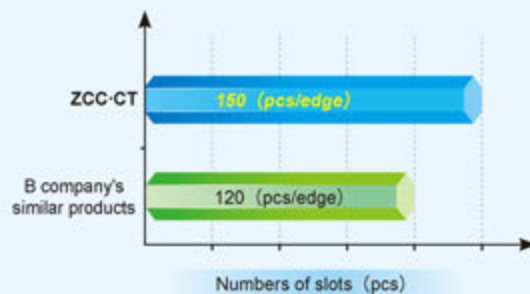

Under the same working conditions, our company's GIMD series inserts have better wear resistance, tool life is longer.

Little squirrel series



QC series shallow grooving tools

Machine industry shallow groove processing tool

Widely used for shallow groove machining of shaft and ring parts in machinery industry

○ Shallow groove series tool grooving range

Groove depth(mm)

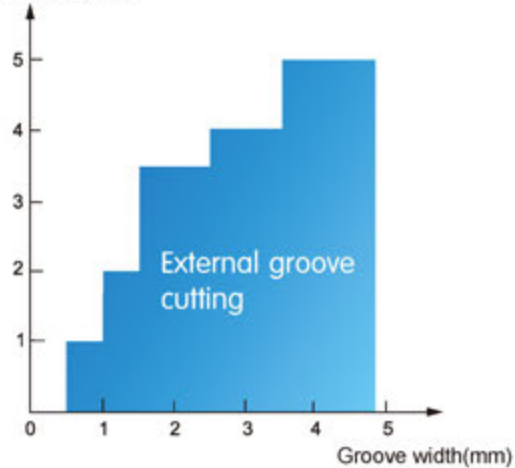

Groove depth(mm)

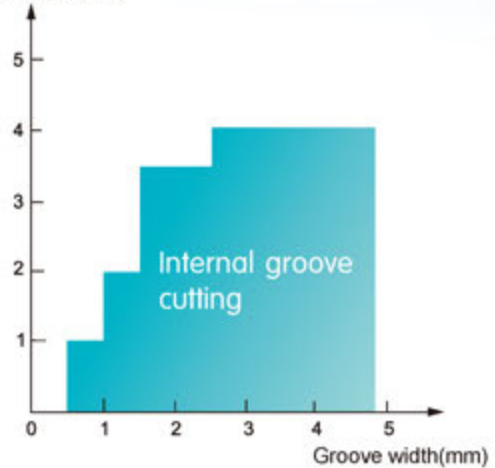

Little-Squirrel Series

Profile turning inserts for parting of aviation titanium alloy, super alloy

-NF

Single-headed precision profile turning inserts

Sharp edge, small cutting force, good surface quality;
Indexing accuracy reaches $\pm 0.025\text{mm}$, safe and stable clamping;
Mainly applied in finishing of super alloy, titanium alloy.

-NM

Precision profile turning inserts

Sharp edge, small cutting force, good surface quality;
Indexing accuracy reaches $\pm 0.025\text{mm}$;
Highly economical, two edges available;
Compatible with little squirrel tool holder, suitable for small depth profile finishing and semi-finishing of super alloy and titanium alloy.



-SM

Single-headed groove turning inserts

Straight edge, excellent surface quality;
Sharp edge, smaller cutting force;
Good chip breaking;
Mainly used for rough machining of super alloy and titanium alloy.

-MM

Straight edge groove turning inserts

High edge strength, sharp edge;
Highly economical, two edges available, compatible with little squirrel tool holder;
With special grades, suitable for roughing with small cutting depths of super alloy and titanium alloy.

Case

Insert: YBG105/ZIMF604N-SM
Hardness of workpiece material: GH4169(HB380)
Cutting data: $V_c=45\text{m/min}$, $f=0.2\text{mm/r}$
Coolant: Water



Products of company A



YBG105/ZIMF604N-SM

Conclusion: Under the same conditions, chip breaking performance is better and the stop time to remove long winding chips is reduced.

-MG Chipbreaker

Customized -MG chipbreaker series

Suitable for parting, grooving, profile turning and turning, etc. Easy machining and unobstructed chip flow lead to improved surface quality.

Human-centered design realizes various application of one single insert, reducing number of tools needed

The insert with same edge width can fit on corresponding tool holders to satisfy the requirements of external, internal and end face grooving or turning by using minimum numbers of inserts and tool holders, effectively reducing cost of tool storage and management.

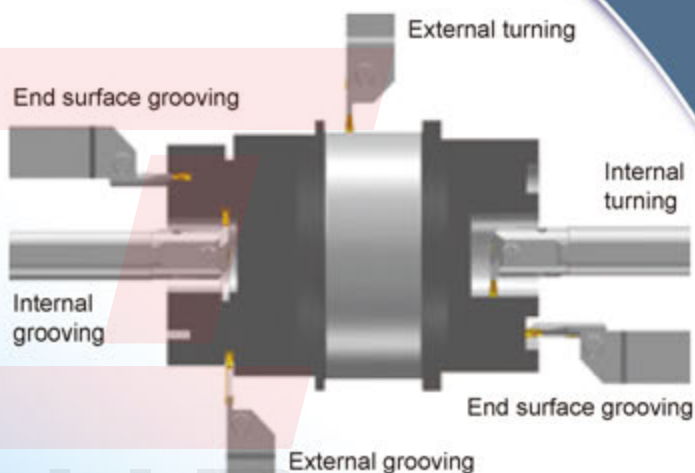

The cutting force is reduced by 20%, and the vibration is diminished.

Unique and professional structure design of parting inserts

- A special flank structure is designed to reduce cutting resistant force by 20% and diminish vibration, which improves the surface quality.
- A special edge design requires less rigidity of machine. It can be used on low power machines.



Little squirrel series

-EG

Precision grooving and profile turning inserts

Special chipbreaker design, suitable for precise grooving of low-carbon steel, stainless steel, adhesive materials and non-ferrous metal.

The tolerance of the edge width CW of precise grooving and profiling inserts can reach ± 0.025 . Inserts can also be mounted on the corresponding specifications of original tool series.

-EG Precision grooving inserts

The edge width can be anything between **1.0-6.5mm** according to your requirements.

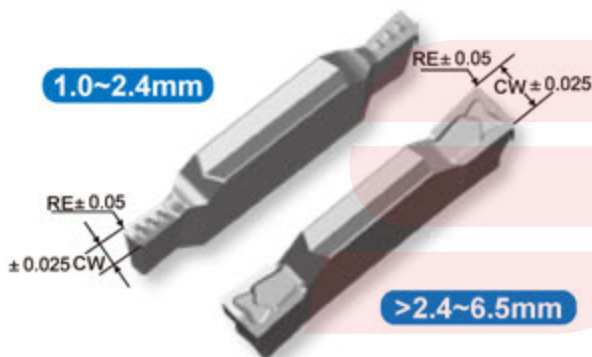

The width of the Little Squirrel series precise grooving inserts can be anything between 1.0mm to 6.5mm, which means products with any edge width or nose radius can be provided according to customers' requirements. The inserts are mainly used for precise grooving, such as sealing slot and locating slot, etc.

-EG Precision profile turning inserts

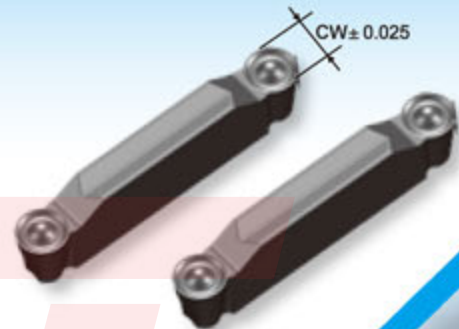

The Little Squirrel series precise profiling and turning inserts are mainly used for precise grooving and profiling.

-LC/-LH

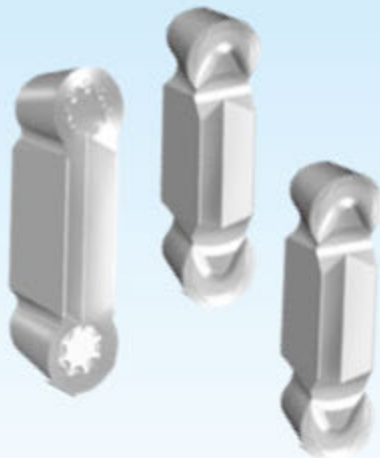

Profile turning inserts for Al

The special chipbreaker for aluminum profiling is designed to combine sharpness and strength of the cutting edge, effectively reducing the friction between chips and the rake face. The inserts are suitable for continuous and intermittent profiling of Al alloy.

Suitable for various machining of Al wheel boss periphery, surface and inner wall, etc.



TURNING Parting and grooving tools

Little squirrel series parting and grooving inserts

Little squirrel series parting, grooving and profiling inserts code key

General turning

Parting and grooving

Little squirrel series parting and grooving inserts

Insert applications

- ZP** > Parting **ZT** > Grooving and turning
- ZR** > Profiling

Code of locating slot

Code of locating slot	A	B	E	F	G	H	K	L
Corresponding edge width of inserts	1.5	2.0	2.5	3.0	4.0	5.0	6.0	8.0

Code of cutting edge number

- S** > Single cutting edge **D** > Double cutting edge

ZP G D 04 04 - M G

Cutting edge width



- 01=1.5mm
- 02=2.0mm
- 025=2.5mm
- 03=3.0mm
- 04=4.0mm
- 05=5.0mm
- 06=6.0mm
- 08=8.0mm

Nose radius



- 02=0.2mm
- 03=0.3mm
- 04=0.4mm
- 08=0.8mm

Tolerance class

- M** > M-level tolerance
- E** > E-level tolerance

Chipbreaker code

- G** > Curve edges universal chipbreaker, suitable for machining various materials
- M** > linear edges universal chipbreaker, suitable for machining various materials
- F** > Special chipbreaker

Parting inserts

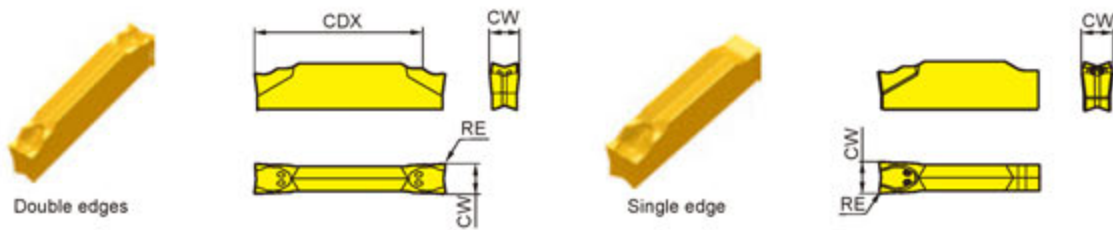

Type	Basic dimensions(mm)			Grade					
	CW ^{+0.1} ₀	RE±0.1	Cutting depth CDX _{max}	CVD Coating		PVD Coating		Cemented carbide	
				YBC151	YBC251	YBG202	YBG302		
Double edges	ZPAD01502-MG	1.5	0.2	12		○	★	○	
	ZPBD0202-MG	2.0	0.2	14		○	★	○	
	ZPED02502-MG	2.5	0.2	17		○	★	★	
	ZPFD0302-MG	3.0	0.2	17		○	★	○	
	ZPGD0402-MG	4.0	0.2	22		○	★	○	
	ZPHD0503-MG	5.0	0.3	22		○	★	○	
Single edge	ZPKD0604-MG	6.0	0.4	22		○	★	○	
	ZPES02502-MG	2.5	0.2			○	★	★	
	ZPFS0302-MG	3.0	0.2			○	★	○	
	ZPGS0402-MG	4.0	0.2			○	★	○	
	ZPHS0503-MG	5.0	0.3			○	★	○	
	ZPKS0604-MG	6.0	0.4			○	★	○	

Single edge tool for cutter plate only

★ Recommended grade (always stock available) ● Available grade (always stock available) ○ Make-to-order

Please reduce the feed speed by 30% when the insert is approaching the centre of workpiece. This can prolong tool life.

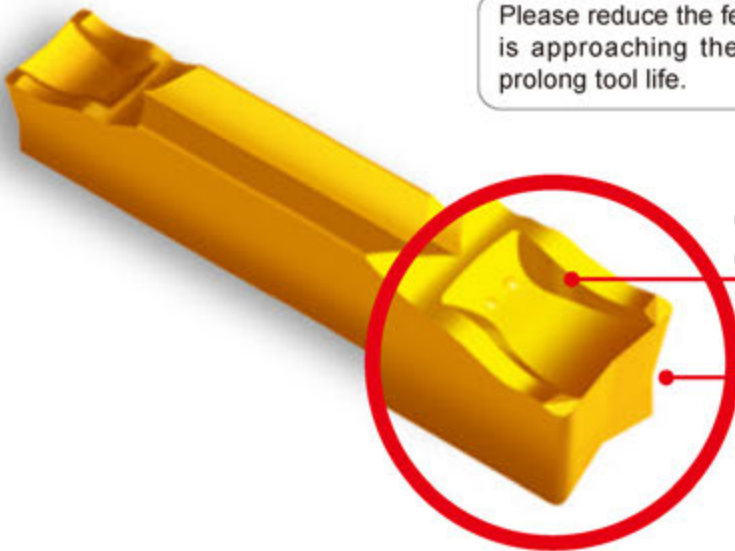

Optimal chipbreaker structure can control chip flow and curling well.

Cutting resistant force is reduced by 20% and vibration is diminished.

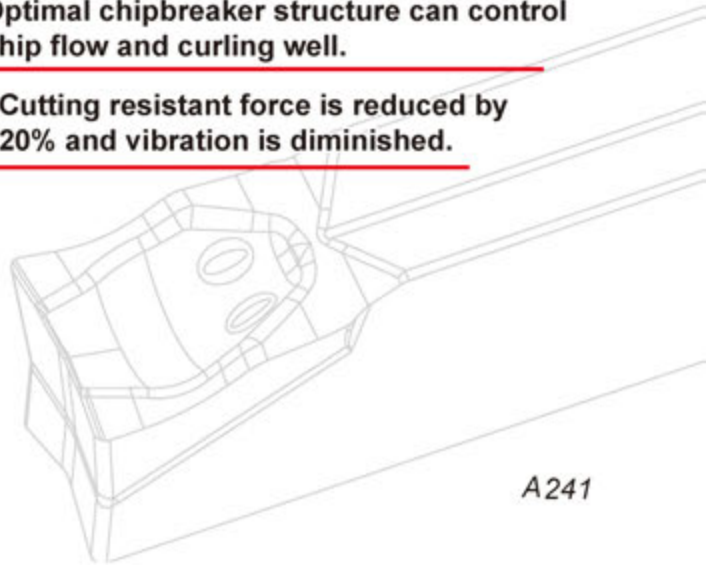

General turning

Parting and grooving

Little squirrel series parting and grooving inserts

Grooving and turning inserts

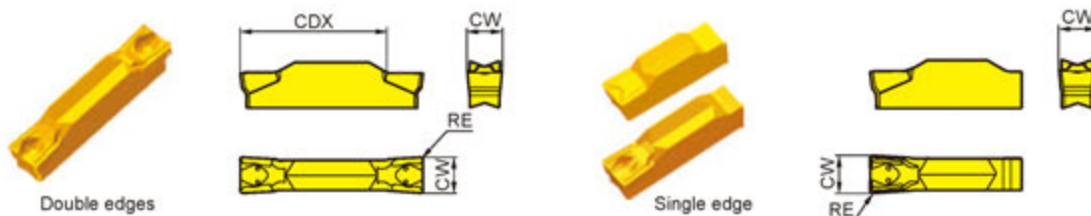

Double edges

Single edge

Type	Basic dimensions(mm)			Grade						
	CW ^{+0.1} ₀	RE±0.1	Cutting depth CDX _{max}	CVD Coating		PVD Coating			Cemented carbide	
				YBC151	YBC251	YBG202	YBG205	YBG302	YD101	
Double edges	ZTED02503-MG	2.5	0.3	17	○	○	●	★	★	
	ZTFD0303-MG	3.0	0.3	17	○	○	●	★	★	
	ZTGD0404-MG	4.0	0.4	22	●	○	●	★	★	
	ZTHD0504-MG	5.0	0.4	22		○	●	★	★	
	ZTKD0608-MG	6.0	0.8	22		○	●	★	★	
Single edge	ZTHS0504-MG	5.0	0.4			○	○	★	○	
	ZTKS0608-MG	6.0	0.8			○	○	★	○	

★ Recommended grade (always stock available) ● Available grade (always stock available) ○ Make-to-order



Type	Basic dimensions(mm)			Grade						
	CW	RE±0.1	Cutting depth CDX _{max}	CVD Coating		PVD Coating			Cemented carbide	
				YBC151	YBC251	YBG202	YBG205	YBG302	YD101	
Double edges	ZTAD01502-MM	1.5±0.03	0.2	12	○	○	●	★	○	
	ZTBD02002-MM	2.0±0.03	0.2	14	○	○	●	★	○	
	ZTED02503-MM	2.5±0.03	0.3	17	○	○	●	★	○	
	ZTFD0303-MM	3.0±0.03	0.3	17	○	○	●	★	○	
	ZTGD0404-MM	4.0±0.04	0.4	22	○	○	●	★	○	
	ZTHD0504-MM	5.0±0.04	0.4	22	○	○	●	★	○	
	ZTKD0608-MM	6.0±0.04	0.8	22	○	○	●	★	○	
	ZTLD0808-MM	8.0±0.05	0.8	28	○	○	●	★	○	

★ Recommended grade (always stock available) ● Available grade (always stock available) ○ Make-to-order

Precise grooving and turning inserts



1.0~2.4mm series

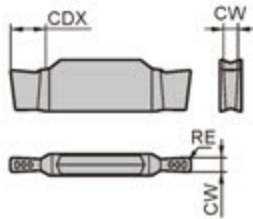

>2.4~6.5mm series

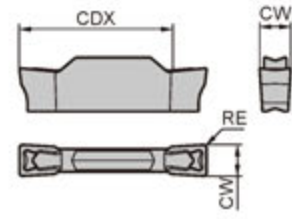

Type	Type			Grade						
	CW \pm 0.025	RE ⁽²⁾ \pm 0.05	Cutting depth CDX _{max}	CVD Coating		PVD Coating			Cemented carbide	
				YBC151	YBC251	YBG202	YBG205	YBG302		YD101
Double edges	ZTCD□□□□□□ ⁽¹⁾ -EG	1.0~1.6	2.6	○	○	○	★	○		
		1.6~2.4		3.4	○	○	○	★	○	
	ZTED□□□□□□-EG	2.4~3.0	17	○	○	○	★	○		
	ZTFD□□□□□□-EG	3.0~3.8	See note. (2)	17	○	○	○	★	○	
	ZTGD□□□□□□-EG	3.8~4.8		22	○	○	○	★	○	
	ZTHD□□□□□□-EG	4.8~5.8	22	○	○	○	★	○		
ZTKD□□□□□□-EG	5.8~6.5	22	○	○	○	★	○			

★ Recommended grade (always stock available) ● Available grade (always stock available) ○ Make-to-order

Note: (1) □ The code here in the description is determined by edge width and nose radius requested by customers. For example, when the customer requires an edge width of 3.5mm and a nose radius of 0.3mm, the description of the insert would be ZTFD03503-EG.

(2) The nose radius range is $0.2 \leq R \leq 0.5$ on request.

GROUP

General turning

Parting and grooving

Little squirrel series parting and grooving inserts

Single-head grooving and turning inserts for semi-finishing and roughing difficult-to-machine materials

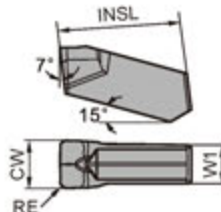

Type	Basic dimensions(mm)				Grade				
					PVD Coating				Cemented carbide
	CW \pm 0.05	RE \pm 0.1	W1	INSL	YBG102	YBG202	YBG205	YBS103	YD101
ZIMF304N-NM	3	0.4	2.4	15.3	★	○	★	●	○
ZIMF406N-NM	4	0.6	3.2	15.3	★	○	★	●	○
ZIMF506N-NM	5	0.6	4.0	15.3	★	○	★	○	○
ZIMF608N-NM	6	0.8	4.0	15.3	★	○	★	○	○

★ Recommended grade (always stock available) ● Available grade (always stock available) ○ Make-to-order

Single-head grooving and turning inserts for semi-finishing and roughing difficult-to-machine materials

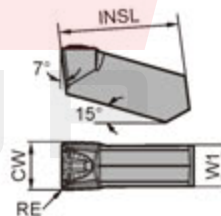

Type	Basic dimensions(mm)				Grade				
					PVD Coating				Cemented carbide
	CW \pm 0.05	RE \pm 0.1	W1	INSL	YBG105	YBG212	YBG205	YBS103	YD101
ZIMF304N-SM	3	0.4	2.4	15.3	★	★		●	○
ZIMF404N-SM	4	0.4	3.2	15.3	★	★		○	○
ZIMF504N-SM	5	0.4	4.0	15.3	★	★		○	○
ZIMF604N-SM	6	0.4	5.1	15.3	★	★		○	○

★ Recommended grade (always stock available) ● Available grade (always stock available) ○ Make-to-order

General turning

Parting and grooving

Little squirrel series parting and grooving inserts



Profiling inserts

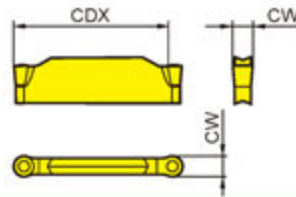

	Type	Basic dimensions(mm)		Grade					
				CVD Coating		PVD Coating			Cemented carbide
		CW ^{+0.1} ₀	Cutting depth CDX _{max}	YBC151	YBC251	YBG202	YBG205	YBG302	YD101
Double edges	ZRED025-MG	2.5	17.5		○	●	★	★	
	ZRFD03-MG	3.0	17		○	●	★	★	
	ZRGD04-MG	4.0	21		○	●	★	★	
	ZRHD05-MG	5.0	20		○	○	★	★	
	ZRKD06-MG	6.0	19		○	●	★	★	

★ Recommended grade (always stock available) ● Available grade (always stock available) ○ Make-to-order

Profiling inserts

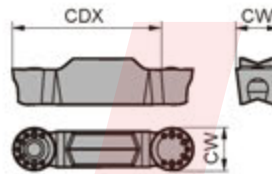

	Type	Basic dimensions(mm)		Grade					
				CVD Coating		PVD Coating			Cemented carbide
		CW ^{+0.25} ₀	Cutting depth CDX _{max}	YBC151	YBC251	YBG105	YBG212	YBG302	YBS103
Double edges	ZRFD03-NM	3	17			★	★		●
	ZRGD04-NM	4	21			★	★		●
	ZRHD05-NM	5	20			★	★		○
	ZRKD06-NM	6	19			★	★		○

★ Recommended grade (always stock available) ● Available grade (always stock available) ○ Make-to-order

Precision profiling inserts

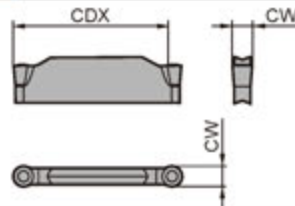

	Type	Basic dimensions(mm)		Grade				
				CVD Coating		PVD Coating		Cemented carbide
		CW ^{±0.025}	Cutting depth CDX _{max}	YBC151	YBC251	YBG202	YBG302	YD101
Double edges	ZRFD03-EG	3.0	17		○		○	
	ZRGD04-EG	4.0	21		○		○	
	ZRHD05-EG	5.0	20		○		○	
	ZRKD06-EG	6.0	19		○		○	

★ Recommended grade (always stock available) ● Available grade (always stock available) ○ Make-to-order

General turning

Parting and grooving

Little squirrel series parting and grooving inserts



Single-head inserts for profiling difficult-to-machine materials

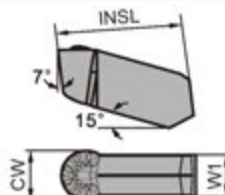

Type	Basic dimensions(mm)			Grade			
				PVD Coating			Cemented carbide
	CW \pm 0.025	W1	INSL	YBG102	YBG202	YBS103	YD101
ZIGQ3N-NM	3	2.4	15.3	★	○	●	○
ZIGQ4N-NM	4	3.2	15.3	★	○	●	○
ZIGQ5N-NM	5	4.0	15.3	★	○	○	○
ZIGQ6N-NM	6	5.0	15.3	★	○	○	○

★ Recommended grade (always stock available) ● Available grade (always stock available) ○ Make-to-order

Single-head inserts for profiling difficult-to-machine materials

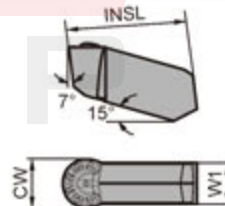

Type	Basic dimensions(mm)			Grade			
				PVD Coating			Cemented carbide
	CW \pm 0.025	W1	INSL	YBG105	YBG212	YBS103	YD101
ZIGQ3N-NF	3	2.4	15.3	★	★	●	
ZIGQ4N-NF	4	3.2	15.3	★	★	○	
ZIGQ5N-NF	5	4.0	15.3	★	★	○	
ZIGQ6N-NF	6	5.0	15.3	★	★	○	

★ Recommended grade (always stock available) ● Available grade (always stock available) ○ Make-to-order

General turning

Parting and grooving

Little squirrel series parting and grooving inserts



Profiling inserts for Al

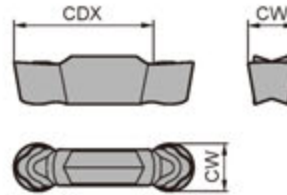

Type	Basic dimensions(mm)		Grade
	CW ± 0.02	Cutting depth CDX _{max}	Cemented carbide
ZRKD06-LH	6.0	19	YD101
ZRLD08-LH	8.0	22	★

★ Recommended grade (always stock available) ● Available grade (always stock available) ○ Make-to-order

Profiling inserts for Al

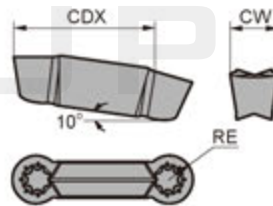

Type	Basic dimensions(mm)			Grade
	CW ± 0.02	RE	Cutting depth CDX _{max}	Cemented carbide
ZILD08-LC	8.0	4.0	22	YD101
				●

★ Recommended grade (always stock available) ● Available grade (always stock available) ○ Make-to-order

General turning

Parting and grooving

Little squirrel series parting and grooving inserts



Grooving and turning inserts

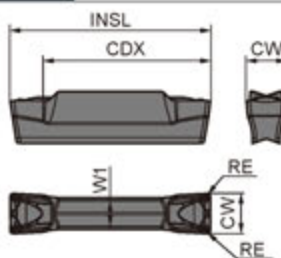

General turning

Parting and grooving

G-series parting and grooving inserts

Type	Basic dimensions(mm)					Grade	
	CW	W1	INSL	CDX	RE	CVD Coating	PVD Coating
GTMD2502-GM	2.5	2	17	14	0.2	●	●
GTMD302-GM	3.0	2.3	17	14	0.2	●	●
GTMD304-GM	3.0	2.3	17	14	0.4	●	●
GTMD402-GM	4.0	3.2	20	17	0.2	●	●
GTMD404-GM	4.0	3.2	20	17	0.4	●	●
GTMD504-GM	5.0	4.2	20	17	0.4	●	●
GTMD508-GM	5.0	4.2	20	17	0.8	●	●
GTMD604-GM	6.0	5.2	20	17	0.4	●	●
GTMD608-GM	6.0	5.2	20	17	0.8	●	●

★ Recommended grade (always stock available) ● Available grade (always stock available) ○ Make-to-order

GROUP

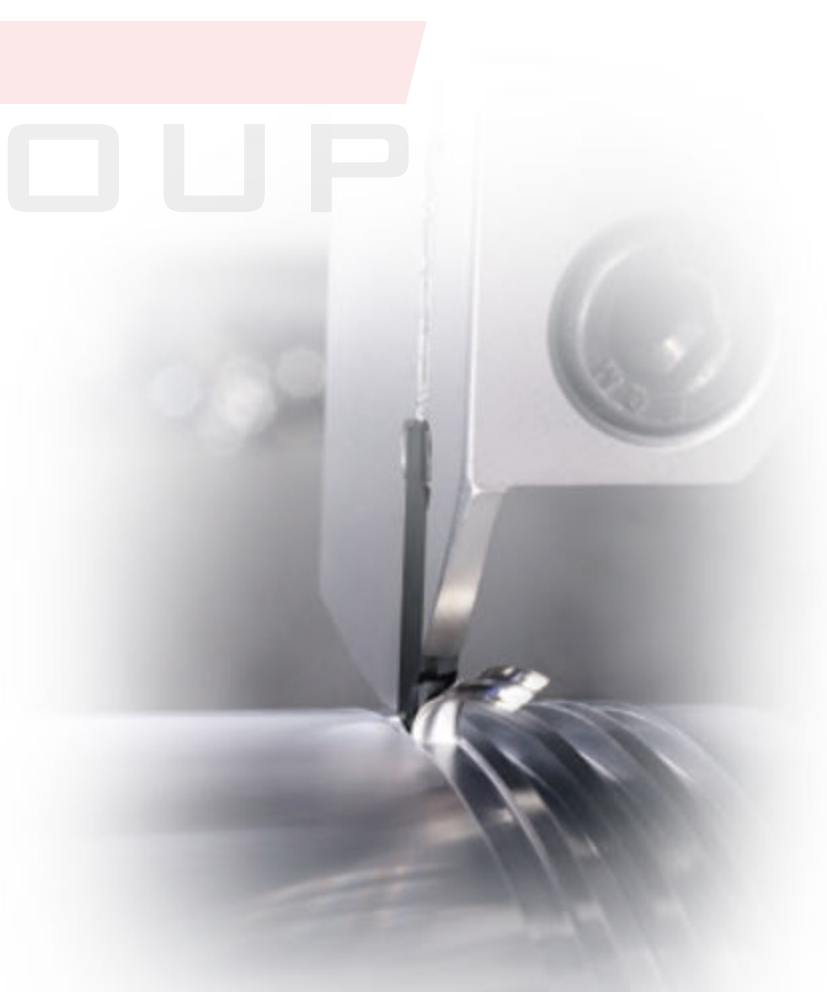



Profiling inserts

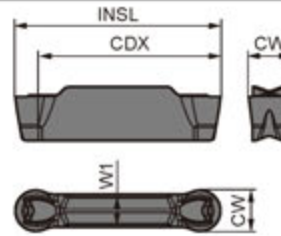

Type	Basic dimensions(mm)					Grade	
						CVD Coating	PVD Coating
	CW	W1	INSL	CDX	RE	YBC103	YB9120
GRMD315-GM	3.0	2.3	17	14	1.5	●	●
GRMD420-GM	4.0	3.2	20	17	2.0	●	●
GRMD525-GM	5.0	4.2	20	17	2.5	●	●
GRMD630-GM	6.0	5.2	20	17	3.0	●	●

★ Recommended grade (always stock available) ● Available grade (always stock available) ○ Make-to-order

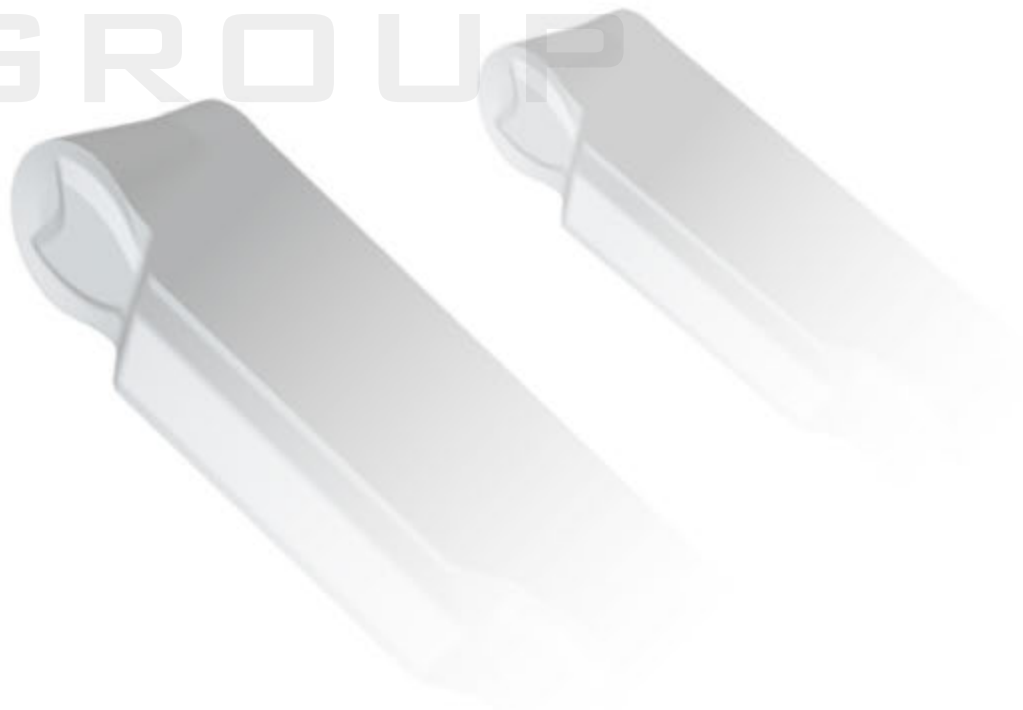

General turning

Parting and grooving

G-series parting and grooving inserts

QC series shallow grooving inserts code key

● Square head shallow grooving inserts

QC

Shallow grooving inserts

22

Cutting edge length code	Inner tangent circle diameter(mm)
11	6.35
16	9.525
22	12.70

R

300



Grooving width(mm)	
Code	Width
050	0.50
100	1.00
...	...
480	4.80

R

03

Rounding or chamfering(mm)	
Code	Size
02	0.2
03	0.3
04	0.4

Direction	
Code	Form
R	Rightward 
L	Leftward 

Inserts tip form	
Code	Form
R	Circular arc 
C	Chamfering 

GROUP

● Round head shallow grooving inserts

QC

Shallow grooving inserts

22

Cutting edge length code	Inner tangent circle diameter(mm)
11	6.35
16	9.525
22	12.70

R

Direction	
Code	Form
R	Rightward 
L	Leftward 

300

Grooving width(mm)	
Code	Width
050	0.50
100	1.00
...	...
480	4.80

R

Head form: round head

Square head shallow grooving inserts



R-type shown

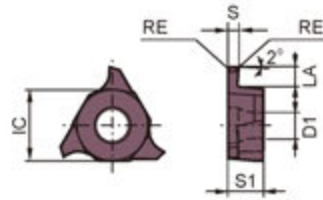

Type		Basic dimensions(mm)						Grade	
		S±0.025	LA	RE	IC	S1	D1	PVD Coating	
								YBG202	YBG205
QC11R/L	120-R02	1.20	1.50	0.2	6.35	3.18	2.8	○	○
	125-R02	1.25	1.50	0.2	6.35	3.18	2.8	○	○
	145-R02	1.45	1.50	0.2	6.35	3.18	2.8	○	○
	150-R02	1.50	1.50	0.2	6.35	3.18	2.8	○	○
	200-R02	2.00	2.00	0.2	6.35	3.18	2.8	○	○
	225-R02	2.25	2.00	0.2	6.35	3.18	2.8	○	○
QC16R/L	110-R01	1.10	2.00	0.1	9.525	3.18	4.4	○	○
	125-R02	1.25	2.00	0.2	9.525	3.18	4.4	○	○
	145-R02	1.45	2.00	0.2	9.525	3.18	4.4	○	○
	150-R02	1.50	2.00	0.2	9.525	3.18	4.4	○	★
	175-R02	1.75	2.00	0.2	9.525	3.18	4.4	○	○
	185-R02	1.85	2.50	0.2	9.525	3.18	4.4	○	○
	200-R02	2.00	2.50	0.2	9.525	3.18	4.4	○	★
	250-R02	2.50	2.50	0.2	9.525	3.18	4.4	○	★
	300-R02	3.00	3.00	0.2	9.525	3.18	4.4	○	★
QC22R/L	125-R02	1.25	2.00	0.2	12.70	4.76	5.5	○	○
	145-R02	1.45	2.00	0.2	12.70	4.76	5.5	○	○
	150-R02	1.50	3.50	0.2	12.70	4.76	5.5	○	★
	175-R02	1.75	3.50	0.2	12.70	4.76	5.5	○	○
	185-R02	1.85	3.50	0.2	12.70	4.76	5.5	○	○
	200-R02	2.00	3.50	0.2	12.70	4.76	5.5	○	★
	230-R02	2.30	3.50	0.2	12.70	4.76	5.5	○	○
	250-R03	2.50	4.00	0.3	12.70	4.76	5.5	○	★
	265-R03	2.65	4.00	0.3	12.70	4.76	5.5	○	○
	280-R03	2.80	4.00	0.3	12.70	4.76	5.5	○	○

★ Recommended grade (always stock available) ● Available grade (always stock available) ○ Make-to-order



Square head shallow grooving inserts



R-type shown

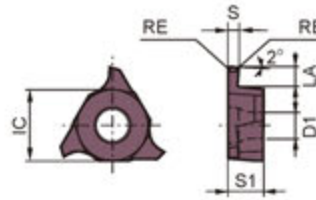

Type		Basic dimensions(mm)						Grade	
		S _{±0.025}	LA	RE	IC	S1	D1	PVD Coating	
								YBG202	YBG205
QC22R/L	300-R03	3.00	4.00	0.3	12.70	4.76	5.5	○	★
	320-R03	3.20	4.00	0.3	12.70	4.76	5.5	○	○
	330-R03	3.30	4.00	0.3	12.70	4.76	5.5	○	○
	350-R03	3.50	5.00	0.3	12.70	4.76	5.5	○	★
	400-R04	4.00	5.00	0.4	12.70	4.76	5.5	○	★
	430-R04	4.30	5.00	0.4	12.70	4.76	5.5	○	○
	450-R04	4.50	5.00	0.4	12.70	4.76	5.5	○	○
	480-R04	4.80	5.00	0.4	12.70	5.06	5.5	○	○

★ Recommended grade (always stock available) ● Available grade (always stock available) ○ Make-to-order

Example of special specification customization:

1. Custom-made insert width of 1.6mm, the tip form of the arc form, arc radius of 0.3mm right blade, IC value of 12.7mm, then the custom-made insert model is QC22R160-R03.
2. Customized edge width range: QC11: 0.50~3.0mm; QC16: 0.50~3.0mm; QC22: 1.0~4.8mm.

Round head shallow grooving inserts



R-type shown

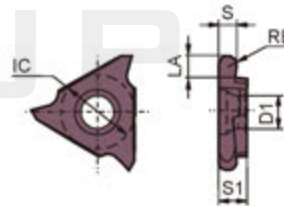

Type		Basic dimensions(mm)						Grade	
		S _{±0.025}	LA	RE	IC	S1	D1	PVD Coating	
								YBG202	YBG205
QC16R/L	200R	2.00	2.50	1.00	12.70	3.18	4.4	○	○
	300R	3.00	2.50	1.50	12.70	3.18	4.4	○	○
QC22R/L	100R	1.00	2.00	0.50	12.70	4.76	5.5	○	○
	150R	1.50	3.50	0.75	12.70	4.76	5.5	○	○
	200R	2.00	3.50	1.00	12.70	4.76	5.5	○	○
	250R	2.50	4.00	1.25	12.70	4.76	5.5	○	○
	300R	3.00	4.00	1.50	12.70	4.76	5.5	○	○
	400R	4.00	5.00	2.00	12.70	4.76	5.5	○	○

★ Recommended grade (always stock available) ● Available grade (always stock available) ○ Make-to-order

Example of special specification customization:

Custom-made inserts width of 1.6mm, the tip form of the arc form, the arc radius of 0.8mm right insert, then the custom-made insert model is QC22R160R.

ZQMX series

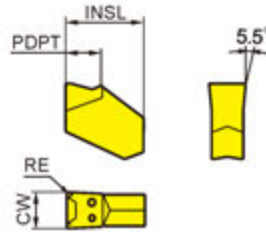

Type	Basic dimensions(mm)				Grade		
					CVD Coating	Cemented carbide	
	PDPT	CW	RE	INSL	YBC251	YC40	YD201
ZQMX3N11-1E	4.4	3.125	0.3	11	●	●	●
ZQMX4N11-1E	4.95	4.125	0.3	11	●	●	●
ZQMX5N11-1E	5.0	5.125	0.3	11	●	●	●
ZQMX6N11-1E	5.28	6.4	0.3	11	●	●	○

★ Recommended grade (always stock available) ● Available grade (always stock available) ○ Make-to-order

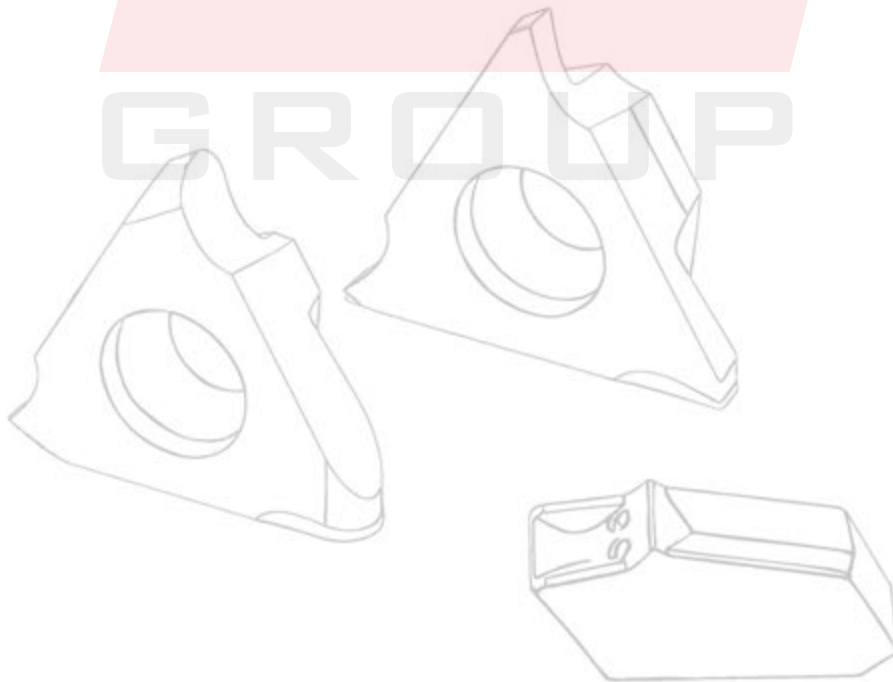



Little squirrel series parting and grooving tools code key

● External and surface turning

General turning

Parting and grooving

Little squirrel series parting and grooving tools

Code of grooving tools

Machining mode

E > External cutting **F** > End surface cutting

Code of locating slot

Accords with locating slot code of insert and corresponds to certain range of insert edge width

Code of edge number of corresponding inserts

S > Single cutting edge **D** > Double cutting edge

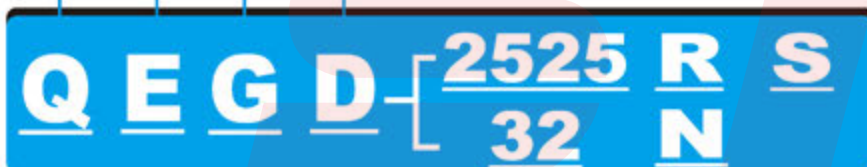

Nose height and width of tool holder

Left and right hand of tool

R > Right **L** > Left **N** > Both are acceptable

Maximum cutting depth

Supplementary code

S: Strengthened tool holder for external and surface deep grooving

The minimum diameter of end surface grooving tools for initial machining

Holder type of end surface grooving tools

H > Straight holder **L** > 90° holder

● Holder for parting blade

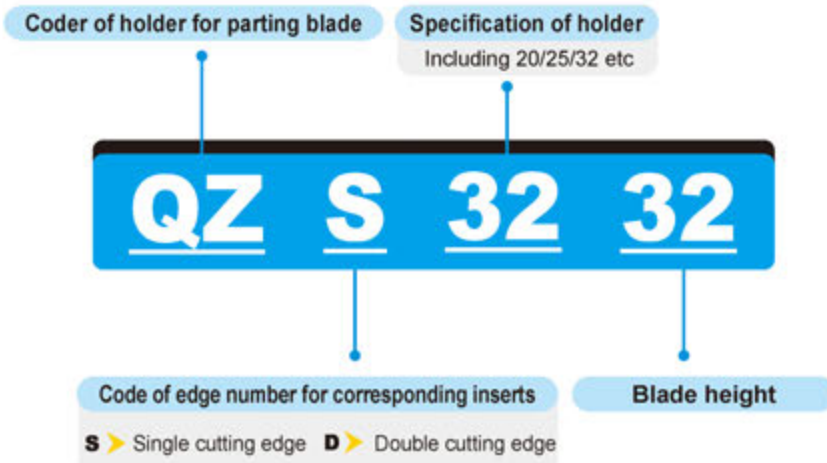

● Internal machining

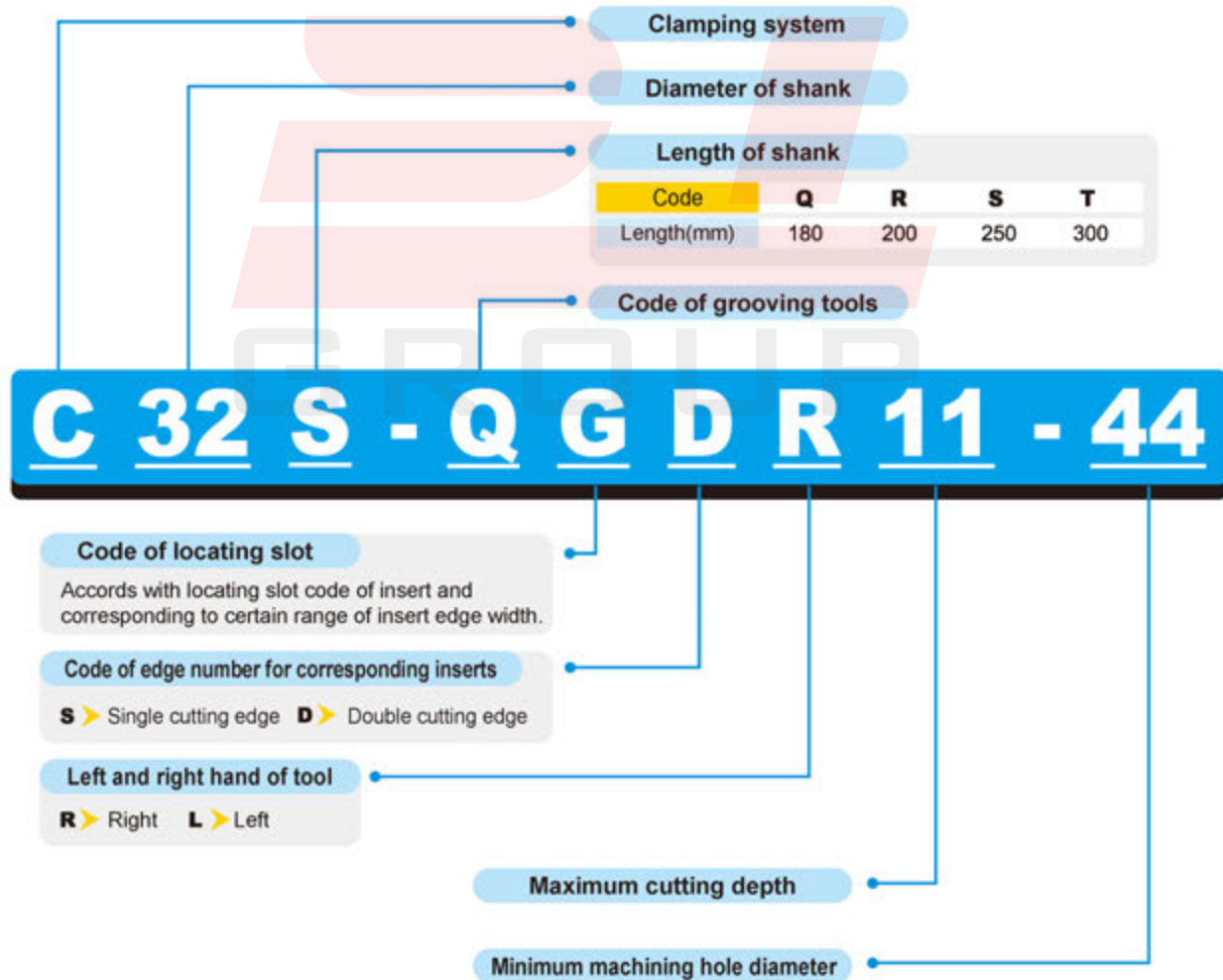

General turning

Parting and grooving

Little squirrel series parting and grooving tools



External parting, grooving and turning tools

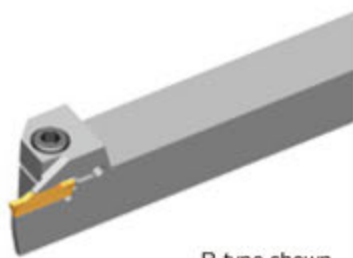

R-type shown

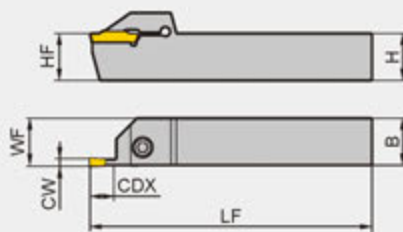

General turning

Parting and grooving

Little squirrel series parting and grooving tools

Type		Stock		Basic dimensions(mm)						Applicable inserts	Screw	Wrench
		R	L	H×B	HF	LF	WF	CW	CDX _{max}			
QEAD	1212R/L07	▲	▲	12×12	12	125	12.15	1.5	7	ZQAD015□□	GB70-85-M4×12	WH30L
	1212R/L12	▲	▲	12×12	12	125	12.15	1.5	12	ZQAD015□□		
	1616R/L07	▲	▲	16×16	16	125	16.15	1.5	7	ZQAD015□□		
	1616R/L12	▲	▲	16×16	16	125	16.15	1.5	12	ZQAD015□□	GB70-85-M5×16	WH40L
	2020R/L07	▲	▲	20×20	20	125	20.15	1.5	7	ZQAD015□□		
	2020R/L12	▲	▲	20×20	20	125	20.15	1.5	12	ZQAD015□□		
QEBD	1212R/L07	▲	▲	12×12	12	125	12.2	2	7	ZQBD02□□	GB70-85-M4×12	WH30L
	1212R/L10	▲	▲	12×12	12	125	12.2	2	10	ZQBD02□□		
	1212R/L14	▲	▲	12×12	12	125	12.2	2	14	ZQBD02□□		
	1616R/L07	▲	▲	16×16	16	125	16.2	2	7	ZQBD02□□	GB70-85-M5×16	WH40L
	1616R/L10	▲	▲	16×16	16	125	16.2	2	10	ZQBD02□□		
	1616R/L14	▲	▲	16×16	16	125	16.2	2	14	ZQBD02□□		
	2020R/L07	▲	▲	20×20	20	125	20.2	2	7	ZQBD02□□	GB70-85-M6×20	WH50L
	2020R/L10	▲	▲	20×20	20	125	20.2	2	10	ZQBD02□□		
	2020R/L14	▲	▲	20×20	20	125	20.2	2	14	ZQBD02□□		
	2525R/L07	▲	▲	25×25	25	150	25.2	2	7	ZQBD02□□	GB70-85-M6×20	WH50L
	2525R/L10	▲	▲	25×25	25	150	25.2	2	10	ZQBD02□□		
	2525R/L14	▲	▲	25×25	25	150	25.2	2	14	ZQBD02□□		
QEED	1616R/L10	▲	▲	16×16	16	125	16.25	2.5	10	ZQED025□□	GB70-85-M5×20	WH40L
	1616R/L17	▲	▲	16×16	16	125	16.25	2.5	17	ZQED025□□		
	2020R/L10	▲	▲	20×20	20	125	20.25	2.5	10	ZQED025□□		
	2020R/L17	▲	▲	20×20	20	125	20.25	2.5	17	ZQED025□□	GB70-85-M6×20	WH50L
	2525R/L10	▲	▲	25×25	25	150	25.25	2.5	10	ZQED025□□		
	2525R/L17	▲	▲	25×25	25	150	25.25	2.5	17	ZQED025□□		
QEFD	1616R/L10	▲	▲	16×16	16	125	16.3	3	10	ZQFD03□□	GB70-85-M5×20	WH40L
	1616R/L17	▲	▲	16×16	16	125	16.3	3	17	ZQFD03□□		
	2020R/L10	▲	▲	20×20	20	125	20.3	3	10	ZQFD03□□		
	2020R/L17	▲	▲	20×20	20	125	20.3	3	17	ZQFD03□□	GB70-85-M6×20	WH50L
	2525R/L10	▲	▲	25×25	25	150	25.3	3	10	ZQFD03□□		
	2525R/L17	▲	▲	25×25	25	150	25.3	3	17	ZQFD03□□		
QEGD	2020R/L13	▲	▲	20×20	20	140	20.5	4	13	ZQGD04□□	GB70-85-M6×20	WH50L
	2020R/L22	▲	▲	20×20	20	140	20.5	4	22	ZQGD04□□		
	2525R/L13	▲	▲	25×25	25	150	25.5	4	13	ZQGD04□□		

▲Stock available △Make-to-order

External parting, grooving and turning tools

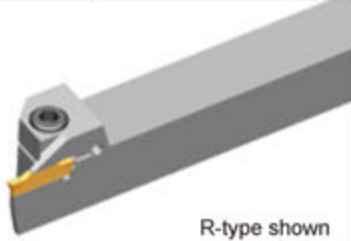

R-type shown

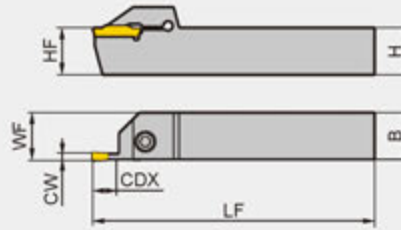

Type		Stock		Basic dimensions(mm)						Applicable inserts	Screw	Wrench
		R	L	H×B	HF	LF	WF	CW	CDX _{max}			
QEGD	2525R/L22	▲	▲	25×25	25	150	25.5	4	22	ZDGD04□□	GB70-85-M6×20	WH50L
	3232R/L13	▲	▲	32×32	32	170	32.5	4	13	ZDGD04□□		
	3232R/L22	▲	▲	32×32	32	170	32.5	4	22	ZDGD04□□		
QEHD	2525R/L13	▲	▲	25×25	25	150	25.5	5	13	ZQHD05□□	GB70-85-M6×20	WH50L
	2525R/L22	▲	▲	25×25	25	150	25.5	5	22	ZQHD05□□		
QEHS	2525N30	▲	▲	25×25	25	150	15	5	30	ZQHS05□□		
QEHD	3232R/L13	▲	▲	32×32	32	170	32.5	5	13	ZQHD05□□		
	3232R/L22	▲	▲	32×32	32	170	32.5	5	22	ZQHD05□□		
QEHS	3232N30	▲	▲	32×32	32	170	18.5	5	30	ZQHS05□□		
QEKD	2525R/L13	▲	▲	25×25	25	150	25.6	6	13	ZQKD06□□	GB70-85-M6×20	WH50L
	2525R/L22	▲	▲	25×25	25	150	25.6	6	22	ZQKD06□□		
QEKs	2525N30	▲	▲	25×25	25	150	15.5	6	30	ZQKS06□□		
QEKD	3232R/L13	▲	▲	32×32	32	170	32.6	6	13	ZQKD06□□		
	3232R/L22	▲	▲	32×32	32	170	32.6	6	22	ZQKD06□□		
QEKs	3232N30	▲	▲	32×32	32	170	19	6	30	ZQKS06□□		
QELD	2525R/L16	▲	▲	25×25	25	150	26	8	16	ZTLD0808-MM	GB70-85-M6×20	WH50L
	2525R/L25	▲	▲	25×25	25	150	26	8	25	ZTLD0808-MM	GB70-85-M6×20	WH50L
	3232R/L28	▲	▲	32×32	32	170	33	8	28	ZTLD0808-MM	GB70-85-M8×30	WH60L

▲Stock available △Make-to-order

Precision grooving and turning tools

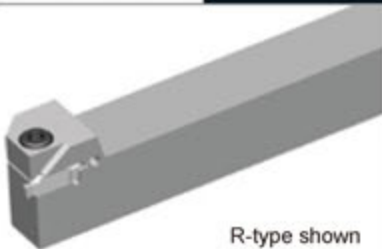

R-type shown

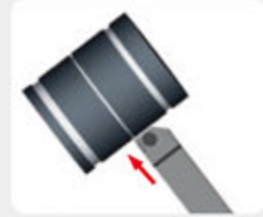
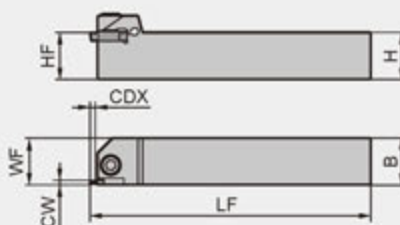

Type		Stock		Basic dimensions(mm)						Applicable inserts	Screw	Wrench
		R	L	H×B	HF	LF	WF	CW	CDX _{max}			
QECD	1616R/L025	△	△	16×16	26	125	14.75	1.0~2.4	2.5	ZTCD□□□□□□-EG	GB70-85-M5×20	WH40L
	2020R/L025	▲	△	20×20	20	125	18.75				GB70-85-M6×20	WH50L
	2525R/L025	▲	△	25×25	25	150	23.75				GB70-85-M6×20	WH50L

▲Stock available △Make-to-order

General turning

Parting and grooving

Little squirrel series parting and grooving tools

External recess and profiling tools



R-type shown

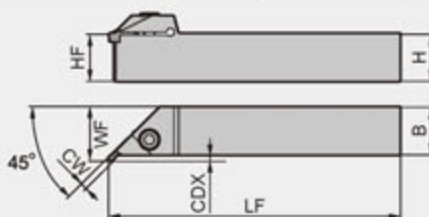

Type	Stock	Basic dimensions(mm)							Applicable inserts	Screw	Wrench	
		R	L	H×B	HF	LF	WF	CW				CDX _{max}
QXFD	2020R/L03-45	△	△	20×20	20	125	23			ZR(T)FD03-□□	GB70-85-M6×20	WH50L
	2525R/L03-45	△	△	25×25	25	150	28	3.0	3.0			
	3232R/L03-45	△	△	32×32	32	170	35					
QXGD	2020R/L03-45	△	△	20×20	20	125	23			ZR(T)GD04-□□	GB70-85-M6×20	WH50L
	2525R/L03-45	△	△	25×25	25	150	28	4.0	3.0			
	3232R/L03-45	△	△	32×32	32	170	35					
QXHD	2020R/L04-45	△	△	20×20	20	125	24			ZR(T)HD05-□□	GB70-85-M6×20	WH50L
	2525R/L04-45	△	△	25×25	25	150	29	5.0	4.0			
	3232R/L04-45	△	△	32×32	32	170	36					
QXKD	2020R/L04-45	△	△	20×20	20	125	24			ZR(T)KD06-□□	GB70-85-M6×20	WH50L
	2525R/L04-45	△	△	25×25	25	150	29	6.0	4.0			
	3232R/L04-45	△	△	32×32	32	170	36					

▲Stock available △Make-to-order

External grooving tools for difficult-to-machine materials

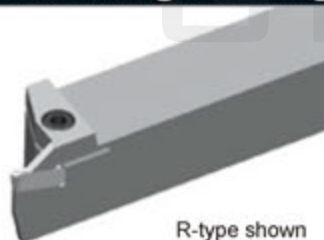

R-type shown

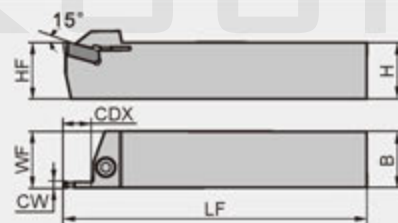

Type	Stock	Basic dimensions(mm)							Applicable inserts	Screw	Wrench	
		R	L	H×B	HF	LF	WF	CW				CDX _{max}
QEFS	2525R/L12-3N	△	△	25×25	25	150	25.3	3	12	ZIGQ3N-□□ ZIMF304N-□□	GB70-85-M6×20	WH50L
	3232R/L22-3N	△	△	32×32	32	170	32.3	3	22			
QEGS	2525R/L12-4N	△	△	25×25	25	150	25.3	4	12	ZIGQ4N-□□ ZIMF40□N-□□	GB70-85-M6×20	WH50L
	3232R/L22-4N	△	△	32×32	32	170	32.3	4	22			
QEHS	2525R/L12-5N	△	△	25×25	25	150	25.4	5	12	ZIGQ5N-□□ ZIMF50□N-□□	GB70-85-M6×20	WH50L
	3232R/L22-5N	△	△	32×32	32	170	32.4	5	22			
QEKS	2525R/L12-6N	△	△	25×25	25	150	25.4	6	12	ZIGQ6N-□□ ZIMF60□N-□□	GB70-85-M6×20	WH50L
	3232R/L22-6N	△	△	32×32	32	170	32.4	6	22			

▲Stock available △Make-to-order

Blade for external parting

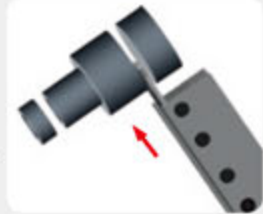
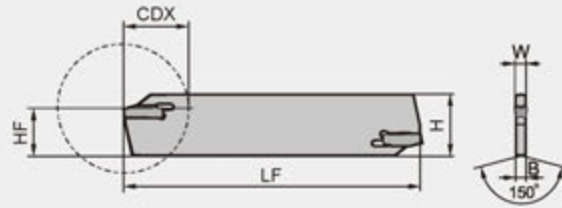

Type	Stock	Basic dimensions(mm)						Applicable inserts	Wrench
		LF	H	HF	B	W	CDX		
QEES26N	▲	110	26	19	2	2.5	60	ZPES02502-MG	W50RL
QEFS26N	▲	110	26	19	2.4	3	60	ZPFS0302-MG	
QEGS26N	▲	110	26	19	3.2	4	70	ZPGS0402-MG	
QEHS26N	▲	110	26	19	4	5	70	ZPHS0503-MG	
QEKS26N	▲	110	26	19	5	6	70	ZPKS0604-MG	
QEES32N	▲	150	32	24.6	2	2.5	100	ZPES02502-MG	
QEFS32N	▲	150	32	24.6	2.4	3	100	ZPFS0302-MG	
QEGS32N	▲	150	32	24.6	3.2	4	120	ZPGS0402-MG	
QEHS32N	▲	150	32	24.6	4	5	120	ZPHS0503-MG	
QEKS32N	▲	150	32	24.6	5	6	120	ZPKS0604-MG	

▲Stock available △Make-to-order

Holder for blade of external parting

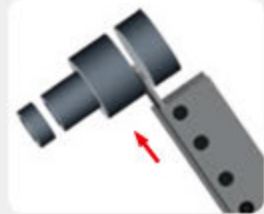
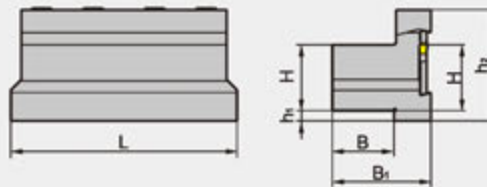

Type	Stock	Basic dimensions(mm)						Clamp	Screw	Wrench
		L	H	h1	h2	B	B1			
QZS2026	▲	86	20	10	46.6	19	38	QZC26	GB70-85-M6×20	WH50L
QZS2526	▲	86	25	5	46.6	23	42	QZC26		
QZS3226	▲	86	30	3	51.6	30	48	QZC26		
QZS2032	▲	110	20	13	50	19	38	QZC32		
QZS2532	▲	110	25	8	50	23	42	QZC32		
QZS3232	▲	110	32	5	54	30	48	QZC32		

▲Stock available △Make-to-order

General turning

Parting and grooving

Little squirrel series parting and grooving tools



End surface grooving and turning tools



L-type shown

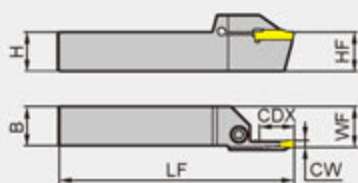

General turning

Parting and grooving

Little squirrel series parting and grooving tools

Type	Stock		Basic dimensions(mm)							Applicable inserts	Screw	Wrench	
	R	L	H×B	HF	LF	WF	CW	CDX _{max}	ØD (min-max)				
QFFD	2020R/L7-48H	▲	▲	20×20	20	150	21	3	7	48-66	ZT(R)FD03□□-□□	GB70-85-M6×20	WH50L
	2020R/L10-48H	▲	▲	20×20	20	150	21	3	10	48-66			
	2020R/L7-60H	△	△	20×20	20	150	21	3	7	60-80			
	2020R/L10-60H	△	△	20×20	20	150	21	3	10	60-80			
	2020R/L7-74H	△	△	20×20	20	150	21	3	7	74-110			
	2020R/L10-74H	△	▲	20×20	20	150	21	3	10	74-110			
	2020R/L7-100H	△	△	20×20	20	150	21	3	7	100-150			
	2020R/L10-100H	△	△	20×20	20	150	21	3	10	100-150			
	2525R/L10-48H	▲	▲	25×25	25	150	26	3	10	48-66			
	2525R/L17-48H	▲	▲	25×25	25	150	26	3	17	48-66			
	2525R/L10-60H	▲	▲	25×25	25	150	26	3	10	60-80			
	2525R/L17-60H	▲	▲	25×25	25	150	26	3	17	60-80			
	2525R/L10-74H	▲	▲	25×25	25	150	26	3	10	74-110			
	2525R/L17-74H	▲	▲	25×25	25	150	26	3	17	74-110			
	2525R/L10-100H	▲	▲	25×25	25	150	26	3	10	100-150			
	2525R/L10-150H	△	△	25×25	25	150	26	3	10	150-260			
2525R/L17-100H	▲	▲	25×25	25	150	26	3	17	100-150				
2525R/L17-100H	△	△	25×25	25	150	26	3	17	150-260				
QFGD	2020R/L10-52H	△	△	20×20	20	150	21	4	10	52-72	ZT(R)GD04□□-□□	GB70-85-M6×20	WH50L
	2020R/L15-52H	△	△	20×20	20	150	21	4	15	52-72			
	2020R/L10-64H	△	▲	20×20	20	150	21	4	10	64-100			
	2020R/L15-64H	△	△	20×20	20	150	21	4	15	64-100			
	2020R/L10-90H	△	△	20×20	20	150	21	4	10	90-140			
	2020R/L15-90H	△	△	20×20	20	150	21	4	15	90-140			
	2020R/L10-130H	△	△	20×20	20	150	21	4	10	130-230			
	2020R/L15-130H	△	△	20×20	20	150	21	4	15	130-230			
	2525R/L13-52H	▲	▲	25×25	25	150	26	4	13	52-72			
	2525R/L22-52H	▲	▲	25×25	25	150	26	4	22	52-72			
	2525R/L13-64H	▲	▲	25×25	25	150	26	4	13	64-100			
	2525R/L22-64H	▲	▲	25×25	25	150	26	4	22	64-100			
	2525R/L13-90H	▲	▲	25×25	25	150	26	4	13	90-140			
	2525R/L22-90H	▲	▲	25×25	25	150	26	4	22	90-140			
	2525R/L13-130H	▲	▲	25×25	25	150	26	4	13	130-230			
	2525R/L22-130H	▲	▲	25×25	25	150	26	4	22	130-230			
2525R/L13-220H	△	△	25×25	25	150	26	4	13	220-600				
2525R/L22-220H	△	△	25×25	25	150	26	4	22	220-600				

▲Stock available △Make-to-order

End surface grooving and turning tools



L-type shown

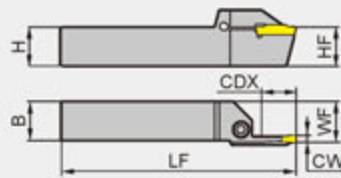

Diameter range of entering



Type	Stock		Basic dimensions(mm)							Applicable inserts	Screw	Wrench	
	R	L	H×B	HF	LF	WF	CW	CDX _{max}	∅D (min-max)				
QFHD	2525R/L13-58H	▲	▲	25×25	25	150	26	5	13	58-96	ZT(R)HD05□□-□□	GB70-85-M6×20	WH50L
	2525R/L22-58H	▲	▲	25×25	25	150	26	5	22	58-96			
	2525R/L13-86H	△	▲	25×25	25	150	26	5	13	86-140			
	2525R/L22-86H	▲	▲	25×25	25	150	26	5	22	86-140			
	2525R/L13-130H	▲	▲	25×25	25	150	26	5	13	130-200			
	2525R/L22-130H	▲	▲	25×25	25	150	26	5	22	130-200			
	2525R/L13-185H	▲	▲	25×25	25	150	26	5	13	185-400			
	2525R/L13-260H	△	△	25×25	25	150	26	5	13	260-1000			
	2525R/L22-185H	▲	▲	25×25	25	150	26	5	22	185-400			
	2525R/L22-260H	△	△	25×25	25	150	26	5	22	260-1000			
QFHS	2525R/L30-185H	△	△	25×25	25	150	26	5	30	185-400	ZTHS0504-MG		
QFKD	2525R/L13-60H	▲	▲	25×25	25	150	26	6	13	60-100	ZT(R)KD06□□-□□	GB70-85-M6×20	WH50L
	2525R/L22-60H	▲	▲	25×25	25	150	26	6	22	60-100			
	2525R/L13-88H	△	▲	25×25	25	150	26	6	13	88-180			
	2525R/L22-88H	▲	▲	25×25	25	150	26	6	22	88-180			
	2525R/L13-160H	▲	▲	25×25	25	150	26	6	13	160-400			
	2525R/L13-280H	△	△	25×25	25	150	26	6	13	280-1200			
	2525R/L22-160H	▲	▲	25×25	25	150	26	6	22	160-400			
	2525R/L22-280H	△	△	25×25	25	150	26	6	22	280-1200			
QFKS	2525R/L30-160H	△	△	25×25	25	150	26	6	30	160-400	ZTKS0608-MG		
QFLD	2525R/L25-75H	▲	▲	25×25	25	150	27	8	25	75-150	ZTLD0808-MM	GB70-85-M6×20	WH50L
	2525R/L25-140H	▲	▲	25×25	25	150	27	8	25	140-400	ZTLD0808-MM	GB70-85-M6×20	WH50L
	3232R/L28-140H	▲	▲	32×32	32	170	30	8	28	140-400	ZTLD0808-MM	GB70-85-M8×30	WH60L

▲Stock available △Make-to-order

General turning

Parting and grooving

Little squirrel series parting and grooving tools



End surface grooving and turning tools

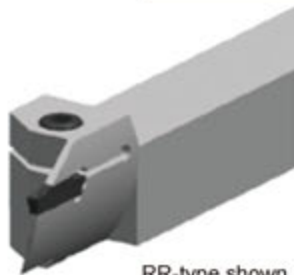

RR-type shown

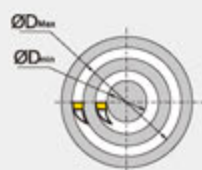
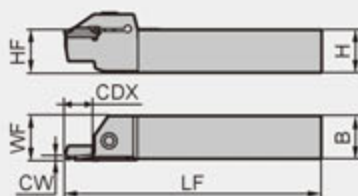

Diameter range of entering



General turning

Parting and grooving

Little squirrel series parting and grooving tools

Type	Stock	Basic dimensions(mm)								Applicable inserts	Screw	Wrench
		H×B	HF	LF	WF	CW	CDX _{max}	ØD (min-max)				
QFFD	2020RR7-48H	△	20×20	20	150	21	3	7	48-66	ZT(R)FD03□□-□□	GB70-85-M6×20	WH50L
	2020RR10-48H	△	20×20	20	150	21	3	10	48-66			
	2020RR7-60H	△	20×20	20	150	21	3	7	60-80			
	2020RR10-60H	△	20×20	20	150	21	3	10	60-80			
	2020RR7-74H	△	20×20	20	150	21	3	7	74-110			
	2020RR10-74H	△	20×20	20	150	21	3	10	74-110			
	2020RR7-100H	△	20×20	20	150	21	3	7	100-150			
	2020RR10-100H	△	20×20	20	150	21	3	10	100-150			
	2525RR10-48H	△	25×25	25	150	26	3	10	48-66			
	2525RR17-48H	△	25×25	25	150	26	3	17	48-66			
	2525RR10-60H	△	25×25	25	150	26	3	10	60-80			
	2525RR17-60H	△	25×25	25	150	26	3	17	60-80			
	2525RR10-74H	△	25×25	25	150	26	3	10	74-110			
	2525RR17-74H	△	25×25	25	150	26	3	17	74-110			
	2525RR10-100H	△	25×25	25	150	26	3	10	100-150			
2525RR17-100H	△	25×25	25	150	26	3	17	100-150				
QFGD	2020RR10-52H	△	20×20	20	150	21	4	10	52-72	ZT(R)GD04□□-□□	GB70-85-M6×20	WH50L
	2020RR15-52H	△	20×20	20	150	26	4	15	52-72			
	2020RR10-64H	△	20×20	20	150	21	4	10	64-100			
	2020RR15-64H	△	20×20	20	150	26	4	15	64-100			
	2020RR10-90H	△	20×20	20	150	21	4	10	90-140			
	2020RR15-90H	△	20×20	20	150	26	4	15	90-140			
	2020RR10-130H	△	20×20	20	150	21	4	10	130-230			
	2020RR15-130H	△	20×20	20	150	26	4	15	130-230			
	2525RR13-52H	△	25×25	25	150	21	4	13	52-72			
	2525RR22-52H	△	25×25	25	150	26	4	22	52-72			
	2525RR13-64H	△	25×25	25	150	21	4	13	64-100			
	2525RR22-64H	△	25×25	25	150	26	4	22	64-100			
	2525RR13-90H	△	25×25	25	150	21	4	13	90-140			
	2525RR22-90H	△	25×25	25	150	26	4	22	90-140			
	2525RR13-130H	△	25×25	25	150	21	4	13	130-230			
2525RR22-130H	△	25×25	25	150	26	4	22	130-230				

▲Stock available △Make-to-order

End surface grooving and turning tools

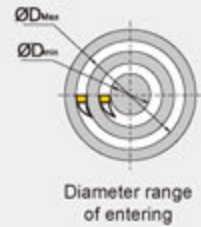
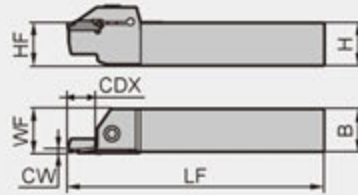
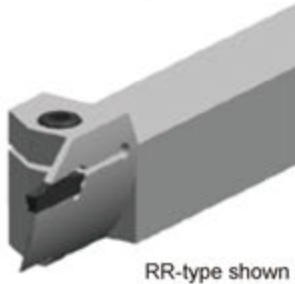

Type	Stock	Basic dimensions(mm)								Applicable inserts	Screw	Wrench
		H×B	HF	LF	WF	CW	CDX _{max}	ØD (min-max)				
QFHD	2525RR13-58H	△	25×25	25	150	26	5	13	58-96	ZT(R)HD05□□-□□	GB70-85-M6×20	WH50L
	2525RR22-58H	△	25×25	25	150	26	5	22	58-96			
	2525RR13-86H	△	25×25	25	150	26	5	13	86-140			
	2525RR22-86H	△	25×25	25	150	26	5	22	86-140			
	2525RR13-130H	△	25×25	25	150	26	5	13	130-200			
	2525RR22-130H	△	25×25	25	150	26	5	22	130-200			
	2525RR13-185H	△	25×25	25	150	26	5	13	185-400			
	2525RR22-185H	△	25×25	25	150	26	5	22	185-400			
QFHS	2525RR30-185H	△	25×25	25	150	26	5	30	185-400	ZTHS0504-MG		
QFKD	2525RR13-60H	△	25×25	25	150	26	6	13	60-100	ZT(R)KD06□□-□□	GB70-85-M6×20	WH50L
	2525RR22-60H	△	25×25	25	150	26	6	22	60-100			
	2525RR13-88H	△	25×25	25	150	26	6	13	88-180			
	2525RR22-88H	△	25×25	25	150	26	6	22	88-180			
	2525RR13-160H	△	25×25	25	150	26	6	13	160-400			
	2525RR22-160H	△	25×25	25	150	26	6	22	160-400			
QFKS	2525RR30-160H	△	25×25	25	150	26	6	30	160-400	ZTKS0608-MG		

▲Stock available △Make-to-order

General turning

Parting and grooving

Little squirrel series parting and grooving tools

End surface grooving and turning tools



LL-type shown

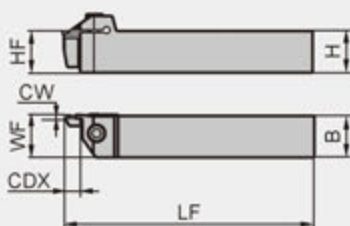

Diameter range of entering



General turning

Parting and grooving

Little squirrel series parting and grooving tools

Type	Stock	Basic dimensions(mm)								Applicable inserts	Screw	Wrench
		H×B	HF	LF	WF	CW	CDX _{max}	ØD (min-max)				
QFFD	2020LL7-48H	△	20×20	20	150	21	3	7	48-66	ZT(R)FD03□□-□□	GB70-85-M6×20	WH50L
	2020LL10-48H	△	20×20	20	150	21	3	10	48-66			
	2020LL7-60H	△	20×20	20	150	21	3	7	60-80			
	2020LL10-60H	△	20×20	20	150	21	3	10	60-80			
	2020LL7-74H	△	20×20	20	150	21	3	7	74-110			
	2020LL10-74H	△	20×20	20	150	21	3	10	74-110			
	2020LL7-100H	△	20×20	20	150	21	3	7	100-150			
	2020LL10-100H	△	20×20	20	150	21	3	10	100-150			
	2525LL10-48H	△	25×25	25	150	26	3	10	48-66			
	2525LL17-48H	△	25×25	25	150	26	3	17	48-66			
	2525LL10-60H	△	25×25	25	150	26	3	10	60-80			
	2525LL17-60H	△	25×25	25	150	26	3	17	60-80			
	2525LL10-74H	△	25×25	25	150	26	3	10	74-110			
	2525LL17-74H	△	25×25	25	150	26	3	17	74-110			
	2525LL10-100H	△	25×25	25	150	26	3	10	100-150			
2525LL17-100H	△	25×25	25	150	26	3	17	100-150				
QFGD	2020LL10-52H	△	20×20	20	150	21	4	10	52-72	ZT(R)GD04□□-□□	GB70-85-M6×20	WH50L
	2020LL15-52H	△	20×20	20	150	26	4	15	52-72			
	2020LL10-64H	△	20×20	20	150	21	4	10	64-100			
	2020LL15-64H	△	20×20	20	150	26	4	15	64-100			
	2020LL10-90H	△	20×20	20	150	21	4	10	90-140			
	2020LL15-90H	△	20×20	20	150	26	4	15	90-140			
	2020LL10-130H	△	20×20	20	150	21	4	10	130-230			
	2020LL15-130H	△	20×20	20	150	26	4	15	130-230			
	2525LL13-52H	△	25×25	25	150	21	4	13	52-72			
	2525LL22-52H	△	25×25	25	150	26	4	22	52-72			
	2525LL13-64H	△	25×25	25	150	21	4	13	64-100			
	2525LL22-64H	△	25×25	25	150	26	4	22	64-100			
	2525LL13-90H	△	25×25	25	150	21	4	13	90-140			
	2525LL22-90H	△	25×25	25	150	26	4	22	90-140			
	2525LL13-130H	△	25×25	25	150	21	4	13	130-230			
2525LL22-130H	△	25×25	25	150	26	4	22	130-230				

▲Stock available △Make-to-order

End surface grooving and turning tools

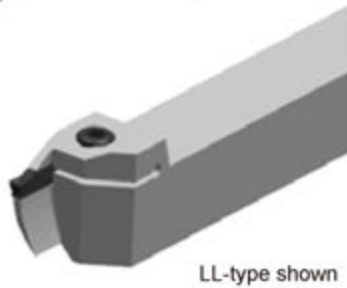

LL-type shown

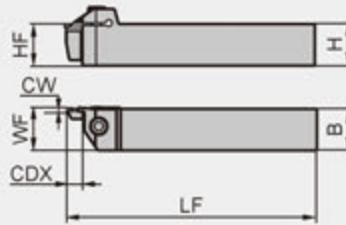

Diameter range of entering



Type	Stock	Basic dimensions(mm)								Applicable inserts	Screw	Wrench
		H×B	HF	LF	WF	CW	CDX _{max}	ØD (min-max)				
QFHD	2525LL13-58H	△	25×25	25	150	26	5	13	58-96	ZT(R)HD05□□-□□	GB70-85-M6×20	WH50L
	2525LL22-58H	△	25×25	25	150	26	5	22	58-96			
	2525LL13-86H	△	25×25	25	150	26	5	13	86-140			
	2525LL22-86H	△	25×25	25	150	26	5	22	86-140			
	2525LL13-130H	△	25×25	25	150	26	5	13	130-200			
	2525LL22-130H	△	25×25	25	150	26	5	22	130-200			
	2525LL13-185H	△	25×25	25	150	26	5	13	185-400			
	2525LL22-185H	△	25×25	25	150	26	5	22	185-400			
QFHS	2525LL30-185H	△	25×25	25	150	26	5	30	185-400	ZTHS0504-MG		
QFKD	2525LL13-60H	△	25×25	25	150	26	6	13	60-100	ZT(R)KD06□□-□□	GB70-85-M6×20	WH50L
	2525LL22-60H	△	25×25	25	150	26	6	22	60-100			
	2525LL13-88H	△	25×25	25	150	26	6	13	88-180			
	2525LL22-88H	△	25×25	25	150	26	6	22	88-180			
	2525LL13-160H	△	25×25	25	150	26	6	13	160-400			
	2525LL22-160H	△	25×25	25	150	26	6	22	160-400			
QFKS	2525LL30-160H	△	25×25	25	150	26	6	30	160-400	ZTKS0608-MG		

▲Stock available △Make-to-order

General turning

Parting and grooving

Little squirrel series parting and grooving tools



L type tools for surface grooving and turning

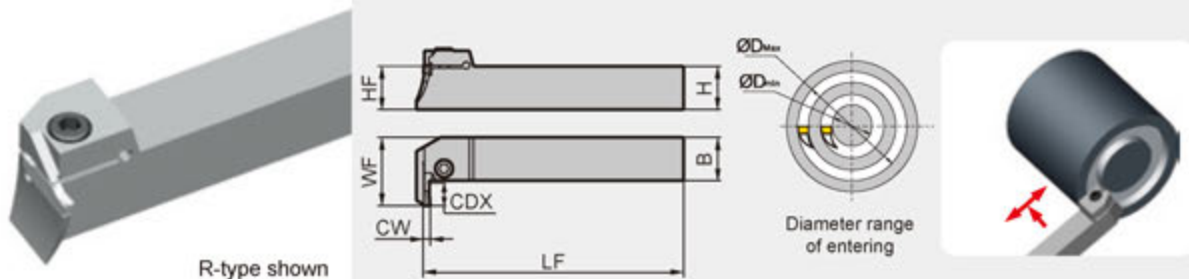

R-type shown

Diameter range of entering

General turning

Parting and grooving

Little squirrel series parting and grooving tools

Type	Stock		Basic dimensions(mm)							Applicable inserts	Screw	Wrench	
	R	L	H×B	HF	LF	WF	CW	CDX _{max}	ØD (min-max)				
QFFD	2020R/L7-48L	△	△	20×20	20	150	28.5	3	7	48-66	ZT(R)FD03□□-□□	GB70-85-M6×20	WH50L
	2020R/L10-48L	△	△	20×20	20	150	31.5	3	10	48-66			
	2020R/L7-60L	△	△	20×20	20	150	28.5	3	7	60-80			
	2020R/L10-60L	△	△	20×20	20	150	31.5	3	10	60-80			
	2020R/L7-74L	△	△	20×20	20	150	28.5	3	7	74-110			
	2020R/L10-74L	△	△	20×20	20	150	31.5	3	10	74-110			
	2020R/L7-100L	△	△	20×20	20	150	28.5	3	7	100-150			
	2020R/L10-100L	△	△	20×20	20	150	31.5	3	10	100-150			
	2525R/L10-48L	▲	▲	25×25	25	150	36.5	3	10	48-66			
	2525R/L17-48L	△	△	25×25	25	150	43.5	3	17	48-66			
	2525R/L10-60L	▲	▲	25×25	25	150	36.5	3	10	60-80			
	2525R/L17-60L	△	△	25×25	25	150	43.5	3	17	60-80			
	2525R/L10-74L	▲	▲	25×25	25	150	36.5	3	10	74-110			
	2525R/L17-74L	△	△	25×25	25	150	43.5	3	17	74-110			
	2525R/L10-100L	▲	▲	25×25	25	150	36.5	3	10	100-150			
2525R/L17-100L	△	△	25×25	25	150	43.5	3	17	100-150				
QFGD	2020R/L10-52L	△	△	20×20	20	150	31.5	4	10	52-72	ZT(R)GD04□□-□□	GB70-85-M6×20	WH50L
	2020R/L15-52L	△	△	20×20	20	150	36.5	4	15	52-72			
	2020R/L10-64L	△	△	20×20	20	150	31.5	4	10	64-100			
	2020R/L15-64L	△	△	20×20	20	150	36.5	4	15	64-100			
	2020R/L10-90L	△	△	20×20	20	150	31.5	4	10	90-140			
	2020R/L15-90L	△	△	20×20	20	150	36.5	4	15	90-140			
	2020R/L10-130L	△	△	20×20	20	150	31.5	4	10	130-230			
	2020R/L15-130L	△	△	20×20	20	150	36.5	4	15	130-230			
	2525R/L13-52L	▲	△	25×25	25	150	39.5	4	13	52-72			
	2525R/L22-52L	△	△	25×25	25	150	48.5	4	22	52-72			
	2525R/L13-64L	△	△	25×25	25	150	39.5	4	13	64-100			
	2525R/L22-64L	△	△	25×25	25	150	48.5	4	22	64-100			
	2525R/L13-90L	△	△	25×25	25	150	39.5	4	13	90-140			
	2525R/L22-90L	▲	△	25×25	25	150	48.5	4	22	90-140			
	2525R/L13-130L	△	△	25×25	25	150	39.5	4	13	130-230			
2525R/L22-130L	▲	▲	25×25	25	150	48.5	4	22	130-230				

▲Stock available △Make-to-order

L type tools for surface grooving and turning

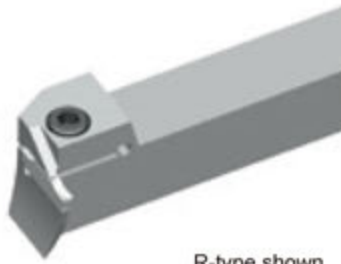

R-type shown

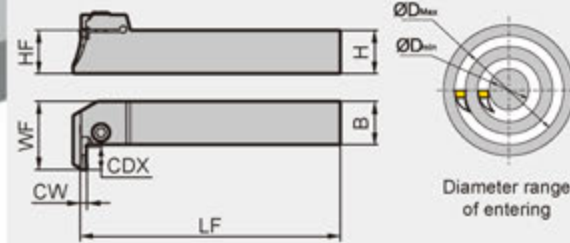

Type	Stock		Basic dimensions(mm)							Applicable inserts	Screw	Wrench	
	R	L	H×B	HF	LF	WF	CW	CDX _{max}	ØD (min-max)				
QFHD	2525R/L13-58L	△	△	25×25	25	150	39.5	5	13	58-96	ZT(R)HD05□□-□□	GB70-85-M6×20	WH50L
	2525R/L22-58L	△	△	25×25	25	150	48.5	5	22	58-96			
	2525R/L13-86L	△	△	25×25	25	150	39.5	5	13	86-140			
	2525R/L22-86L	△	△	25×25	25	150	48.5	5	22	86-140			
	2525R/L13-130L	△	△	25×25	25	150	39.5	5	13	130-200			
	2525R/L22-130L	△	△	25×25	25	150	48.5	5	22	130-200			
	2525R/L13-185L	△	△	25×25	25	150	39.5	5	13	185-400			
	2525R/L22-185L	▲	△	25×25	25	150	48.5	5	22	185-400			
QFHS	2525R/L30-185L	△	△	25×25	25	150	56.5	5	30	185-400	ZTHS0504-MG		
QFKD	2525R/L13-60L	▲	▲	25×25	25	150	39.5	6	13	60-100	ZT(R)KD06□□-□□	GB70-85-M6×20	WH50L
	2525R/L22-60L	▲	▲	25×25	25	150	48.5	6	22	60-100			
	2525R/L13-88L	△	▲	25×25	25	150	39.5	6	13	88-180			
	2525R/L22-88L	▲	▲	25×25	25	150	48.5	6	22	88-180			

▲Stock available △Make-to-order

General turning

Parting and grooving

Little squirrel series parting and grooving tools

Internal grooving and turning tools



R-type shown

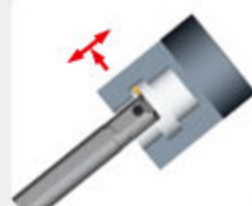
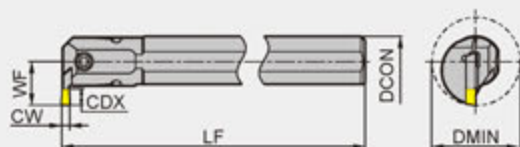

Type	Stock		Basic dimensions(mm)						Applicable inserts	Screw	Wrench
	R	L	DCON	LF	WF	CW	CDX _{max}	DMIN			
C20Q-QEDR/L05-27	▲	▲	20	180	15.2	2.5	5	27	ZTED025□□ ZRED025□□	GB70-85-M4×12	WH30L
C25R-QEDR/L07-33	▲	▲	25	200	20.3	2.5	7	33			
C32S-QEDR/L09-42	▲	▲	32	250	25.3	2.5	9	42	ZTFD03□□ ZRFD03□□	GB70-85-M4×12	WH30L
C20Q-QFDR/L05-27	▲	▲	20	180	15.2	3	5	27			
C25R-QFDR/L07-33	▲	▲	25	200	20.3	3	7	33	GB70-85-M5×20	WH40L	
C32S-QFDR/L09-42	▲	▲	32	250	25.3	3	9	42			ZTGD04□□ ZRGD04□□
C25R-QGDR/L08-35	▲	▲	25	200	21.5	4	8	35	GB70-85-M6×20	WH50L	
C32S-QGDR/L11-44	▲	▲	32	250	27.5	4	11	44			GB70-85-M6×20
C40T-QGDR/L13-54	▲	▲	40	300	33.5	4	13	54	ZTHD05□□ ZRHD05□□	GB70-85-M6×20	
C25R-QHDR/L08-35	▲	▲	25	200	21.5	5	8	35			GB70-85-M6×20
C32S-QHDR/L11-44	▲	▲	32	250	27.5	5	11	44	GB70-85-M5×16	WH40L	
C40T-QHDR/L13-54	▲	▲	40	300	33.5	5	13	54			GB70-85-M6×20
C25R-QKDR/L08-35	▲	▲	25	200	21.5	6	8	35	ZTKD06□□ ZRKD06□□	GB70-85-M5×16	
C32S-QKDR/L11-44	▲	▲	32	250	27.5	6	11	44			GB70-85-M6×20
C40T-QKDR/L13-54	▲	▲	40	300	33.5	6	13	54	GB70-85-M6×20		

▲Stock available △Make-to-order

Profile turning tools for Al



R-type shown

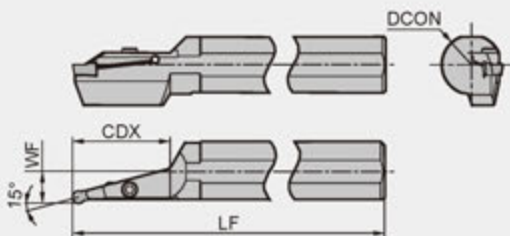

Type	Stock		Basic dimensions(mm)					Applicable inserts	Screw	Wrench
	R	L	DMIN (Minimum machining diameter)	DCON	WF	LF	CDX			
C40X-QLDR/L65-15A	▲	▲	160	40	21	320	65	ZRLD08-LH	GB70-85-M6×20	WH50L
C40X-QLDR/L80-15A	▲	△	160	40	21	320	80			
C40X-QKDR/L60-15A	△	△	160	40	20	320	60	ZRKD06-LH		
C40X-QKDR/L75-15A	△	△	160	40	20	320	75	ZRKD06-LH		

▲Stock available △Make-to-order

External parting, grooving and turning tools



L-type shown

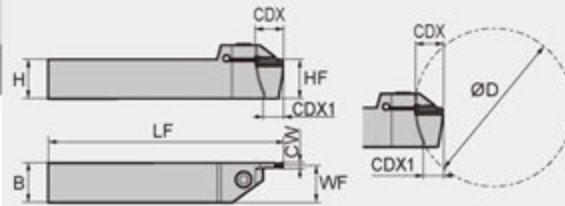

Type	Stock		Basic dimensions(mm)							Applicable inserts	Screw	Wrench
	R	L	H×B	LF	WF	CW	CDX	ØD	CDX			
GED1616R/L08-2.5	▲	▲	16×16	125	16.3	2.5	8	∞	8	GOMD25□□-□□	GB70-85-M5×16	WH40L
GED1616R/L14-2.5	▲	▲	16×16	125	16.3	2.5	14	60	11			
GED2020R/L08-2.5	▲	▲	20×20	125	20.3	2.5	8	∞	8	GOMD25□□-□□	GB70-85-M6×20	WH50L
GED2020R/L14-2.5	▲	▲	20×20	125	20.3	2.5	14	100	11			
GED2525R/L08-2.5	▲	▲	25×25	150	25.3	2.5	8	∞	8	GOMD25□□-□□	GB70-85-M6×20	WH50L
GED2525R/L14-2.5	▲	▲	25×25	150	25.3	2.5	14	100	11			
GED1616R/L08-3	▲	▲	16×16	125	16.45	3	8	∞	8	GOMD3□□□-□□	GB70-85-M5×16	WH40L
GED1616R/L14-3	▲	▲	16×16	125	16.45	3	14	60	11			
GED2020R/L08-3	▲	▲	20×20	125	20.45	3	8	∞	8	GOMD3□□□-□□	GB70-85-M6×20	WH50L
GED2020R/L14-3	▲	▲	20×20	125	20.45	3	14	100	11			
GED2525R/L08-3	▲	▲	25×25	150	25.45	3	8	∞	8	GOMD3□□□-□□	GB70-85-M6×20	WH50L
GED2525R/L14-3	▲	▲	25×25	150	25.45	3	14	100	11			
GED2020R/L10-4	▲	▲	20×20	125	20.5	4	10	∞	10	GOMD4□□□-□□	GB70-85-M6×20	WH50L
GED2020R/L17-4	▲	▲	20×20	125	20.5	4	17	100	14			
GED2525R/L10-4	▲	▲	25×25	150	25.5	4	10	∞	10	GOMD4□□□-□□	GB70-85-M6×20	WH50L
GED2525R/L17-4	▲	▲	25×25	150	25.5	4	17	100	14			
GED3232R/L10-4	▲	▲	32×32	170	32.5	4	10	∞	10	GOMD4□□□-□□	GB70-85-M8×20	WH60L
GED3232R/L17-4	▲	▲	32×32	170	32.5	4	17	∞	17			
GED2525R/L10-5	▲	▲	25×25	150	25.5	5	10	∞	10	GOMD5□□□-□□	GB70-85-M6×20	WH50L
GED2525R/L17-5	▲	▲	25×25	150	25.5	5	17	100	14			
GED3232R/L10-5	▲	▲	32×32	170	32.5	5	10	∞	10	GOMD5□□□-□□	GB70-85-M8×20	WH60L
GED3232R/L17-5	▲	▲	32×32	170	32.5	5	17	∞	17			
GED2525R/L10-6	▲	▲	25×25	150	25.5	6	10	∞	10	GOMD6□□□-□□	GB70-85-M6×20	WH50L
GED2525R/L17-6	▲	▲	25×25	150	25.5	6	17	100	14			
GED3232R/L10-6	▲	▲	32×32	170	32.5	6	10	∞	10	GOMD6□□□-□□	GB70-85-M8×20	WH60L
GED3232R/L17-6	▲	▲	32×32	170	32.5	6	17	∞	17			

▲Stock available

△Make-to-order

General turning

Parting and grooving

G-series parting and grooving tools



End surface grooving and turning tools



L-type shown

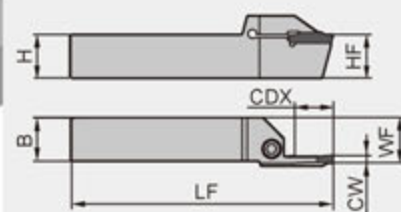

Diameter range of entering



Type	Stock		Basic dimensions(mm)							Applicable inserts	Screw	Wrench			
	R	L	H×B	HF	LF	WF	CW	CDX _{max}	∅D (min-max)						
GFD2020R/L08-28H-3	△	△	20×20	20	150	21	3	8	28-35	GOMD3□□-□□	GB70-85-M6×20	WH50L			
GFD2020R/L08-34H-3	△	△	20×20	20	150	21	3	8	34-45						
GFD2020R/L08-44H-3	△	△	20×20	20	150	21	3	8	44-60						
GFD2020R/L14-58H-3	△	△	20×20	20	150	21	3	14	58-80						
GFD2020R/L14-78H-3	△	△	20×20	20	150	21	3	14	78-130						
GFD2020R/L14-126H-3	△	△	20×20	20	150	21	3	14	126-230						
GFD2525R/L08-28H-3	▲	▲	25×25	25	150	26	3	8	28-35						
GFD2525R/L08-34H-3	▲	▲	25×25	25	150	26	3	8	34-45						
GFD2525R/L08-44H-3	▲	▲	25×25	25	150	26	3	8	44-60						
GFD2525R/L14-58H-3	▲	▲	25×25	25	150	26	3	14	58-80						
GFD2525R/L14-78H-3	▲	▲	25×25	25	150	26	3	14	78-130						
GFD2525R/L14-126H-3	▲	▲	25×25	25	150	26	3	14	126-230						
GFD2020R/L10-28H-4	△	△	20×20	20	150	21	4	10	28-35				GOMD4□□-□□	GB70-85-M6×20	WH50L
GFD2020R/L10-34H-4	△	△	20×20	20	150	21	4	10	34-45						
GFD2020R/L10-44H-4	△	△	20×20	20	150	21	4	10	44-60						
GFD2020R/L17-58H-4	△	△	20×20	20	150	21	4	17	58-80						
GFD2020R/L17-78H-4	△	△	20×20	20	150	21	4	17	78-130						
GFD2020R/L17-126H-4	△	△	20×20	20	150	21	4	17	126-230						
GFD2525R/L10-28H-4	▲	▲	25×25	25	150	26	4	10	28-35						
GFD2525R/L10-34H-4	▲	▲	25×25	25	150	26	4	10	34-45						
GFD2525R/L10-44H-4	▲	▲	25×25	25	150	26	4	10	44-60						
GFD2525R/L17-58H-4	▲	▲	25×25	25	150	26	4	17	58-80						
GFD2525R/L17-78H-4	▲	▲	25×25	25	150	26	4	17	78-130						
GFD2525R/L17-126H-4	▲	▲	25×25	25	150	26	4	17	126-230						
GFD2525R/L17-200H-4	▲	▲	25×25	25	150	26	4	17	200-480						

▲ Stock available △ Make-to-order

General turning

Parting and grooving

G-series parting and grooving tools

End surface grooving and turning tools



L-type shown

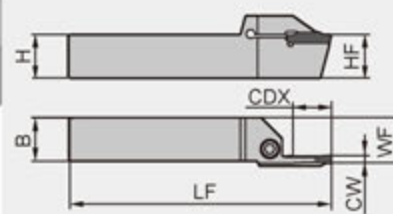

Diameter range of entering



Type	Stock		Basic dimensions(mm)							Applicable inserts	Screw	Wrench
	R	L	H×B	HF	LF	WF	CW	CDX _{max}	ØD (min-max)			
GFD2020R/L10-35H-5	△	△	20×20	20	150	21	5	10	35-45	GOMD5□□-□□	GB70-85-M6×20	WH50L
GFD2020R/L10-44H-5	△	△	20×20	20	150	21	5	10	44-58			
GFD2020R/L17-56H-5	△	△	20×20	20	150	21	5	17	56-86			
GFD2020R/L17-84H-5	△	△	20×20	20	150	21	5	17	84-158			
GFD2020R/L17-156H-5	△	△	20×20	20	150	21	5	17	156-500			
GFD2525R/L10-35H-5	▲	▲	25×25	25	150	26	5	10	35-45			
GFD2525R/L10-44H-5	▲	▲	25×25	25	150	26	5	10	44-58			
GFD2525R/L17-56H-5	▲	▲	25×25	25	150	26	5	17	56-86			
GFD2525R/L17-84H-5	▲	▲	25×25	25	150	26	5	17	84-158			
GFD2525R/L17-156H-5	▲	▲	25×25	25	150	26	5	17	156-500			
GFD2020R/L10-35H-6	△	△	20×20	20	150	21	6	10	35-50	GOMD6□□-□□		
GFD2020R/L17-48H-6	△	△	20×20	20	150	21	6	17	48-80			
GFD2020R/L17-78H-6	△	△	20×20	20	150	21	6	17	78-168			
GFD2020R/L17-160H-6	△	△	20×20	20	150	21	6	17	160-660			
GFD2525R/L10-35H-6	▲	▲	25×25	25	150	26	6	10	35-50			
GFD2525R/L17-48H-6	▲	▲	25×25	25	150	26	6	17	48-80			
GFD2525R/L17-78H-6	▲	▲	25×25	25	150	26	6	17	78-168			
GFD2525R/L17-160H-6	▲	▲	25×25	25	150	26	6	17	160-660			

▲Stock available

△Make-to-order

General turning

Parting and grooving

G-series parting and grooving tools



End surface grooving and turning tools



RR-type shown

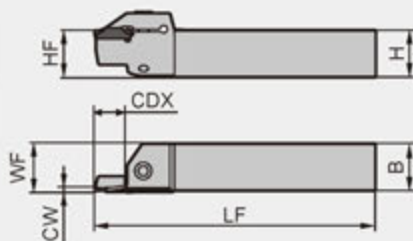

Diameter range of entering



General turning

Parting and grooving

G-series parting and grooving tools

Type	Stock	Basic dimensions(mm)							Applicable inserts	Screw	Wrench			
		H×B	HF	LF	WF	CW	CDX _{max}	∅D (min-max)						
GFD2020RR08-28H-3	△	20×20	20	150	21	3	8	28-35	GMD3□□-□□	GB70-85-M6x20	WH50L			
GFD2020RR08-34H-3	△	20×20	20	150	21	3	8	34-45						
GFD2020RR08-44H-3	△	20×20	20	150	21	3	8	44-60						
GFD2020RR14-58H-3	△	20×20	20	150	21	3	14	58-80						
GFD2020RR14-78H-3	△	20×20	20	150	21	3	14	78-130						
GFD2020RR14-126H-3	△	20×20	20	150	21	3	14	126-230						
GFD2525RR08-28H-3	△	25×25	25	150	26	3	8	28-35						
GFD2525RR08-34H-3	△	25×25	25	150	26	3	8	34-45						
GFD2525RR08-44H-3	△	25×25	25	150	26	3	8	44-60						
GFD2525RR14-58H-3	△	25×25	25	150	26	3	14	58-80						
GFD2525RR14-78H-3	△	25×25	25	150	26	3	14	78-130						
GFD2525RR14-126H-3	△	25×25	25	150	26	3	14	126-230						
GFD2020RR10-28H-4	△	20×20	20	150	21	4	10	28-35				GMD4□□-□□	GB70-85-M6x20	WH50L
GFD2020RR10-34H-4	△	20×20	20	150	21	4	10	34-45						
GFD2020RR10-44H-4	△	20×20	20	150	21	4	10	44-60						
GFD2020RR17-58H-4	△	20×20	20	150	21	4	17	58-80						
GFD2020RR17-78H-4	△	20×20	20	150	21	4	17	78-130						
GFD2020RR17-126H-4	△	20×20	20	150	21	4	17	126-230						
GFD2525RR10-28H-4	△	25×25	25	150	26	4	10	28-35						
GFD2525RR10-34H-4	△	25×25	25	150	26	4	10	34-45						
GFD2525RR10-44H-4	△	25×25	25	150	26	4	10	44-60						
GFD2525RR17-58H-4	△	25×25	25	150	26	4	17	58-80						
GFD2525RR17-78H-4	△	25×25	25	150	26	4	17	78-130						
GFD2525RR17-126H-4	△	25×25	25	150	26	4	17	126-230						
GFD2525RR17-200H-4	△	25×25	25	150	26	4	17	200-480						

▲Stock available △Make-to-order

End surface grooving and turning tools



RR-type shown

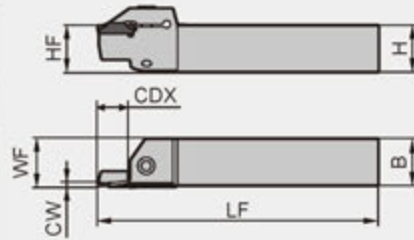

Diameter range of entering



Type	Stock	Basic dimensions(mm)							Applicable inserts	Screw	Wrench
		H×B	HF	LF	WF	CW	CDX _{max}	∅D (min-max)			
GFD2020RR10-35H-5	△	20×20	20	150	21	5	10	35-45	GOMD5□□-□□	GB70-85-M6x20	WH50L
GFD2020RR10-44H-5	△	20×20	20	150	21	5	10	44-58			
GFD2020RR17-56H-5	△	20×20	20	150	21	5	17	56-86			
GFD2020RR17-84H-5	△	20×20	20	150	21	5	17	84-158			
GFD2020RR17-156H-5	△	20×20	20	150	21	5	17	156-500			
GFD2525RR10-35H-5	△	25×25	25	150	26	5	10	35-45			
GFD2525RR10-44H-5	△	25×25	25	150	26	5	10	44-58			
GFD2525RR17-56H-5	△	25×25	25	150	26	5	17	56-86			
GFD2525RR17-84H-5	△	25×25	25	150	26	5	17	84-158			
GFD2525RR17-156H-5	△	25×25	25	150	26	5	17	156-500			
GFD2020RR10-35H-6	△	20×20	20	150	21	6	10	35-50	GOMD6□□-□□		
GFD2020RR17-48H-6	△	20×20	20	150	21	6	17	48-80			
GFD2020RR17-78H-6	△	20×20	20	150	21	6	17	78-168			
GFD2020RR17-160H-6	△	20×20	20	150	21	6	17	160-660			
GFD2525RR10-35H-6	△	25×25	25	150	26	6	10	35-50			
GFD2525RR17-48H-6	△	25×25	25	150	26	6	17	48-80			
GFD2525RR17-78H-6	△	25×25	25	150	26	6	17	78-168			
GFD2525RR17-160H-6	△	25×25	25	150	26	6	17	160-660			

▲Stock available

△Make-to-order

General turning

Parting and grooving

G-series parting and grooving tools

End surface grooving and turning tools



LL-type shown

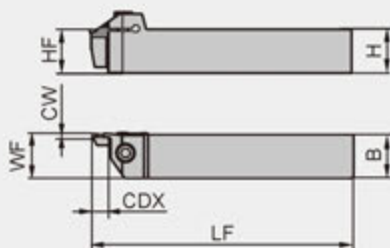

Diameter range of entering



General turning

Parting and grooving

G-series parting and grooving tools

Type	Stock	Basic dimensions(mm)							Applicable inserts	Screw	Wrench			
		H×B	HF	LF	WF	CW	CDX _{max}	ØD (min-max)						
GFD2020LL08-28H-3	△	20×20	20	150	21	3	8	28-35	GMD3□□-□□	GB70-85-M6x20	WH50L			
GFD2020LL08-34H-3	△	20×20	20	150	21	3	8	34-45						
GFD2020LL08-44H-3	△	20×20	20	150	21	3	8	44-60						
GFD2020LL14-58H-3	△	20×20	20	150	21	3	14	58-80						
GFD2020LL14-78H-3	△	20×20	20	150	21	3	14	78-130						
GFD2020LL14-126H-3	△	20×20	20	150	21	3	14	126-230						
GFD2525LL08-28H-3	△	25×25	25	150	26	3	8	28-35						
GFD2525LL08-34H-3	△	25×25	25	150	26	3	8	34-45						
GFD2525LL08-44H-3	△	25×25	25	150	26	3	8	44-60						
GFD2525LL14-58H-3	△	25×25	25	150	26	3	14	58-80						
GFD2525LL14-78H-3	△	25×25	25	150	26	3	14	78-130						
GFD2525LL14-126H-3	△	25×25	25	150	26	3	14	126-230						
GFD2020LL10-28H-4	△	20×20	20	150	21	4	10	28-35				GMD4□□-□□	GB70-85-M6x20	WH50L
GFD2020LL10-34H-4	△	20×20	20	150	21	4	10	34-45						
GFD2020LL10-44H-4	△	20×20	20	150	21	4	10	44-60						
GFD2020LL17-58H-4	△	20×20	20	150	21	4	17	58-80						
GFD2020LL17-78H-4	△	20×20	20	150	21	4	17	78-130						
GFD2020LL17-126H-4	△	20×20	20	150	21	4	17	126-230						
GFD2525LL10-28H-4	△	25×25	25	150	26	4	10	28-35						
GFD2525LL10-34H-4	△	25×25	25	150	26	4	10	34-45						
GFD2525LL10-44H-4	△	25×25	25	150	26	4	10	44-60						
GFD2525LL17-58H-4	△	25×25	25	150	26	4	17	58-80						
GFD2525LL17-78H-4	△	25×25	25	150	26	4	17	78-130						
GFD2525LL17-126H-4	△	25×25	25	150	26	4	17	126-230						
GFD2525LL17-200H-4	△	25×25	25	150	26	4	17	200-480						

▲Stock available △Make-to-order

End surface grooving and turning tools



LL-type shown

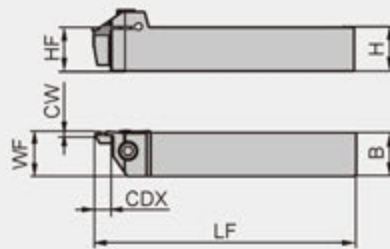

Diameter range of entering



Type	Stock	Basic dimensions(mm)							Applicable inserts	Screw	Wrench
		H×B	HF	LF	WF	CW	CDX _{max}	∅D (min-max)			
GFD2020LL10-35H-5	△	20×20	20	150	21	5	10	35-45	GOMD5□□-□□	GB70-85-M6x20	WH50L
GFD2020LL10-44H-5	△	20×20	20	150	21	5	10	44-58			
GFD2020LL17-56H-5	△	20×20	20	150	21	5	17	56-86			
GFD2020LL17-84H-5	△	20×20	20	150	21	5	17	84-158			
GFD2020LL17-156H-5	△	20×20	20	150	21	5	17	156-500			
GFD2525LL10-35H-5	△	25×25	25	150	26	5	10	35-45			
GFD2525LL10-44H-5	△	25×25	25	150	26	5	10	44-58			
GFD2525LL17-56H-5	△	25×25	25	150	26	5	17	56-86			
GFD2525LL17-84H-5	△	25×25	25	150	26	5	17	84-158			
GFD2525LL17-156H-5	△	25×25	25	150	26	5	17	156-500			
GFD2020LL10-35H-6	△	20×20	20	150	21	6	10	35-50	GOMD6□□-□□		
GFD2020LL17-48H-6	△	20×20	20	150	21	6	17	48-80			
GFD2020LL17-78H-6	△	20×20	20	150	21	6	17	78-168			
GFD2020LL17-160H-6	△	20×20	20	150	21	6	17	160-660			
GFD2525LL10-35H-6	△	25×25	25	150	26	6	10	35-50			
GFD2525LL17-48H-6	△	25×25	25	150	26	6	17	48-80			
GFD2525LL17-78H-6	△	25×25	25	150	26	6	17	78-168			
GFD2525LL17-160H-6	△	25×25	25	150	26	6	17	160-660			

▲Stock available

△Make-to-order

General turning

Parting and grooving

G-series parting and grooving tools



L type tools for surface grooving and turning



R-type shown

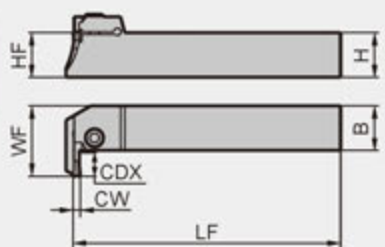

Diameter range of entering



General turning

Parting and grooving

G-series parting and grooving tools

Type	Stock		Basic dimensions(mm)							Applicable inserts	Screw	Wrench
	R	L	H×B	HF	LF	WF	CW	CDX _{max}	ØD (min-max)			
GFD2020R/L08-28L-3	△	△	20×20	20	150	29	3	8	28-35	G□MD3□□-□□	GB70-85-M6×20	WH50L
GFD2020R/L08-34L-3	△	△	20×20	20	150	29	3	8	34-45			
GFD2020R/L08-44L-3	△	△	20×20	20	150	29	3	8	44-60			
GFD2020R/L14-58L-3	△	△	20×20	20	150	35	3	14	58-80			
GFD2020R/L14-78L-3	△	△	20×20	20	150	35	3	14	78-130			
GFD2020R/L14-126L-3	△	△	20×20	20	150	35	3	14	126-230			
GFD2525R/L08-28L-3	△	△	25×25	25	150	34	3	8	28-35			
GFD2525R/L08-34L-3	△	△	25×25	25	150	34	3	8	34-45			
GFD2525R/L08-44L-3	△	△	25×25	25	150	34	3	8	44-60			
GFD2525R/L14-58L-3	△	△	25×25	25	150	40	3	14	58-80			
GFD2525R/L14-78L-3	△	△	25×25	25	150	40	3	14	78-130			
GFD2525R/L14-126L-3	△	△	25×25	25	150	40	3	14	126-230			
GFD2020R/L10-28L-4	△	△	20×20	20	150	31	4	10	28-35	G□MD4□□-□□	GB70-85-M6×20	WH50L
GFD2020R/L10-34L-4	△	△	20×20	20	150	31	4	10	34-45			
GFD2020R/L10-44L-4	△	△	20×20	20	150	31	4	10	44-60			
GFD2020R/L17-58L-4	△	△	20×20	20	150	38	4	17	58-80			
GFD2020R/L17-78L-4	△	△	20×20	20	150	38	4	17	78-130			
GFD2020R/L17-126L-4	△	△	20×20	20	150	38	4	17	126-230			
GFD2525R/L10-28L-4	△	△	25×25	25	150	36	4	10	28-35			
GFD2525R/L10-34L-4	△	△	25×25	25	150	36	4	10	34-45			
GFD2525R/L10-44L-4	△	△	25×25	25	150	36	4	10	44-60			
GFD2525R/L17-58L-4	△	△	25×25	25	150	43	4	17	58-80			
GFD2525R/L17-78L-4	△	△	25×25	25	150	43	4	17	78-130			
GFD2525R/L17-126L-4	△	△	25×25	25	150	43	4	17	126-230			
GFD2525R/L17-200L-4	△	△	25×25	25	150	43	4	17	200-480			

▲ Stock available △ Make-to-order

L type tools for surface grooving and turning



R-type shown

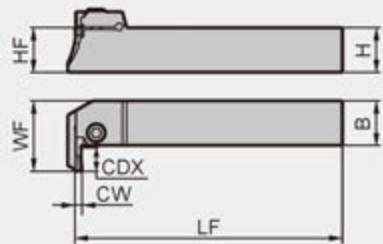

Diameter range of entering



Type	Stock		Basic dimensions(mm)							Applicable inserts	Screw	Wrench
	R	L	H×B	HF	LF	WF	CW	CDX _{max}	∅D (min-max)			
GFD2020R/L10-35L-5	△	△	20×20	20	150	31	5	10	35-45	GDM5□□-□□	GB70-85-M6×20	WH50L
GFD2020R/L10-44L-5	△	△	20×20	20	150	31	5	10	44-58			
GFD2020R/L17-56L-5	△	△	20×20	20	150	38	5	17	56-86			
GFD2020R/L17-84L-5	△	△	20×20	20	150	38	5	17	84-158			
GFD2020R/L17-156L-5	△	△	20×20	20	150	38	5	17	156-500			
GFD2525R/L10-35L-5	△	△	25×25	25	150	36	5	10	35-45			
GFD2525R/L10-44L-5	△	△	25×25	25	150	43	5	10	44-58			
GFD2525R/L17-56L-5	△	△	25×25	25	150	43	5	17	56-86			
GFD2525R/L17-84L-5	△	△	25×25	25	150	43	5	17	84-158			
GFD2525R/L17-156L-5	△	△	25×25	25	150	43	5	17	156-500			
GFD2020R/L10-35L-6	△	△	20×20	20	150	31	6	10	35-50	GDM6□□-□□		
GFD2020R/L17-48L-6	△	△	20×20	20	150	38	6	17	48-80			
GFD2020R/L17-78L-6	△	△	20×20	20	150	38	6	17	78-168			
GFD2020R/L17-160L-6	△	△	20×20	20	150	38	6	17	160-660			
GFD2525R/L10-35L-6	△	△	25×25	25	150	36	6	10	35-50			
GFD2525R/L17-48L-6	△	△	25×25	25	150	43	6	17	48-80			
GFD2525R/L17-78L-6	△	△	25×25	25	150	43	6	17	78-168			
GFD2525R/L17-160L-6	△	△	25×25	25	150	43	6	17	160-660			

▲Stock available

△Make-to-order

General turning

Parting and grooving

G-series parting and grooving tools

Internal grooving and turning tools



R-type shown

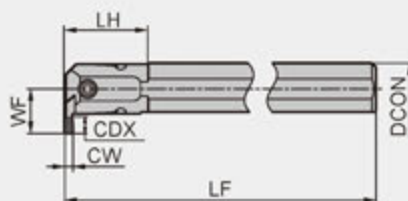

Type	Stock		Basic dimensions(mm)							Applicable inserts	Screw	Wrench
	R	L	CW	DMIN	DCON	LF	LH	WF	CDX			
GID2016R/L04-2.5	▲	▲	2.5	20	16	150	25	12	4	G□MD25□□-□□	I60M5×13	WT20IP
GID2520R/L05-2.5	▲	▲	2.5	25	20	180	30	15	5		GB70-85-M4×12	WH30L
GID3225R/L07-2.5	▲	▲	2.5	32	25	200	40	19.5	7		GB70-85-M5×12	WH40L
GID2016R/L05-3	▲	▲	3.0	20	16	150	25	12	5	G□MD3□□-□□	I60M5×13	WT20IP
GID2520R/L06-3	▲	▲	3.0	25	20	180	30	16	6		GB70-85-M4×12	WH30L
GID3225R/L08-3	▲	▲	3.0	32	25	200	40	20.5	8		GB70-85-M5×12	WH40L
GID2520R/L06-4	▲	▲	4.0	25	20	180	30	16	6	G□MD4□□-□□	GB70-85-M4×12	WH30L
GID3225R/L08-4	▲	▲	4.0	32	25	200	40	20.5	8		GB70-85-M5×12	WH40L
GID4032R/L11-4	▲	▲	4.0	40	32	250	50	27	11		GB70-85-M6×14	WH50L
GID3225R/L08-5	▲	▲	5.0	32	25	200	40	20.5	8	G□MD5□□-□□	GB70-85-M5×12	WH40L
GID4032R/L11-5	▲	▲	5.0	40	32	250	50	27	11		GB70-85-M6×14	WH50L
GID3225R/L08-6	▲	▲	6.0	32	25	200	40	20.5	8		G□MD6□□-□□	GB70-85-M5×12
GID4032R/L11-6	▲	▲	6.0	40	32	250	50	27	11	GB70-85-M6×14		WH50L

▲ Stock available △ Make-to-order

QC series shallow grooving tools code key

● External shallow grooving tools

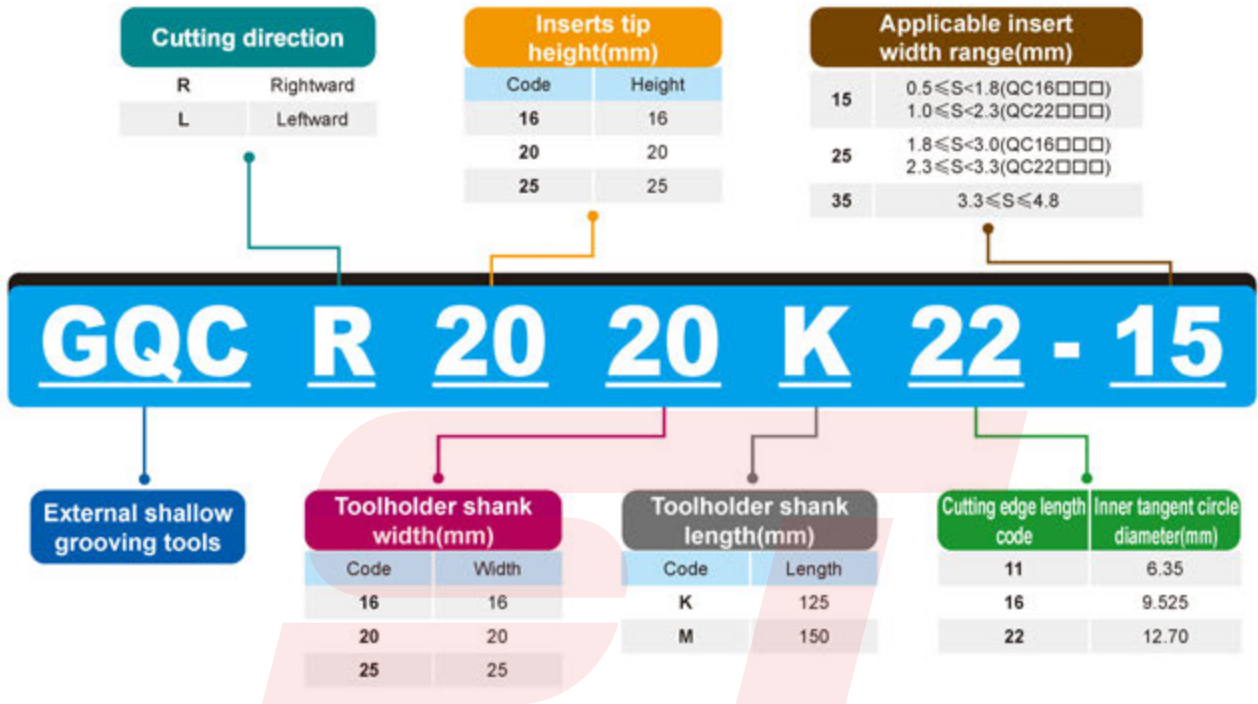

● Internal shallow grooving tools

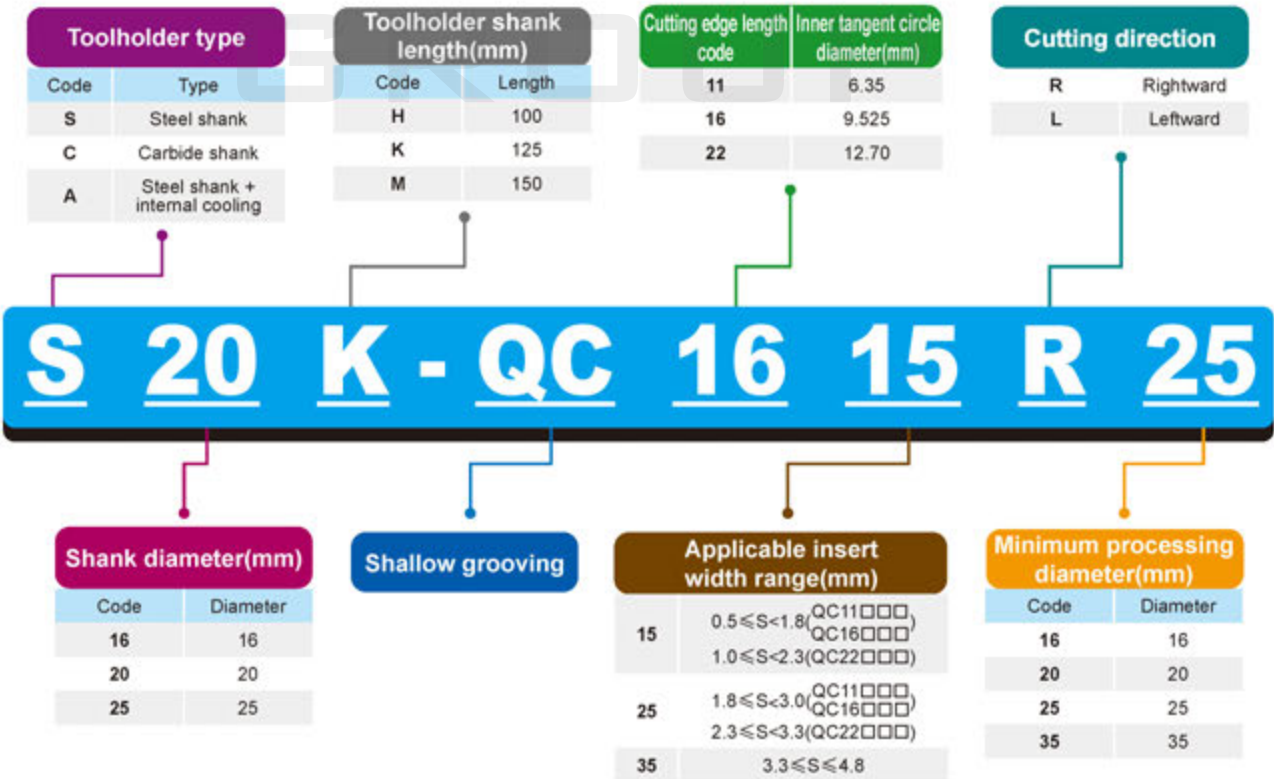

General turning

Parting and grooving

QC series shallow grooving tools

External shallow grooving tools

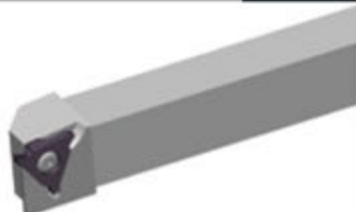

R-type shown. The right (R) holder is fitted with a right (R) insert, and the left (L) holder is fitted with a left (L) insert.

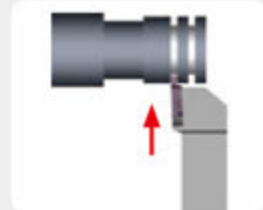

Type	Stock	Basic dimensions(mm)						Width (mm)	Applicable inserts	Screw	Wrench	
		H	HF	B	WF	LH	LF					
GQCR/L	1616K16-15	▲	16	16	16	21	25.5	125	QC16R/L 110~180	I60M3.5×10	WT15IP	
	2020K16-15	▲	20	20	20	25		125				
	2525M16-15	▲	25	25	25	30		150				
	1616K16-25	▲	16	16	16	21		125				QC16R/L 180~300
	2020K16-25	▲	20	20	20	25		125				
	2525M16-25	▲	25	25	25	30		150				
	2020K22-15	▲	20	20	20	25		125	1.0-2.3	QC22R/L 100~230	I60M5×13	WT20IP
	2525M22-15	▲	25	25	25	30		150	QC22R/L 230~330			
	2020K22-25	▲	20	20	20	25		125				
	2525M22-25	▲	25	25	25	30		150				
	2020K22-35	▲	20	20	20	25		125	3.3-4.8	QC22R/L 330~480		
	2525M22-35	▲	25	25	25	30		150				

▲Stock available △Make-to-order

Internal shallow grooving tools



L-type shown. The right (R) holder is fitted with a right (R) insert, and the left (L) holder is fitted with a left (L) insert.

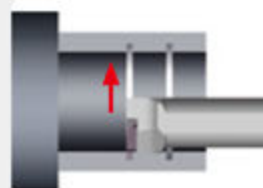
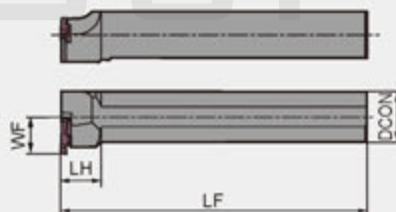
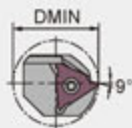

Type	Stock	Basic dimensions(mm)					Width (mm)	Applicable inserts	Screw	Wrench
		DMIN	DCON	WF	LH	LF				
S20K-QC1115R/L 16	▲	16	20	11.1	40	125	1.2-1.8	QC11R/L 120~180	I60M2.5×6.5	WT07IP
S20K-QC1125R/L 16	▲	16	20	11.1	40	125	1.8-3.0	QC11R/L 180~300		
S16H-QC1115R/L 20	▲	21	16	11.5	12	100	1.2-1.8	QC11R/L 120~180		
S16H-QC1125R/L 20	▲	21	16	11.5	12	100	1.8-3.0	QC11R/L 180~300		
S20M-QC1615R/L 25	▲	26	20	12.5	15	150	1.1-1.8	QC16R/L 110~180	I60M3.5×10	WT15IP
S20M-QC1625R/L 25	▲			12.5			1.8-3.0	QC16R/L 180~300		
S25M-QC2215R/L 35	▲	35	25	18.2	20	150	1.0-2.3	QC22R/L 100~230	I60M5×13	WT20IP
S25M-QC2225R/L 35	▲			18.2			2.3-3.3	QC22R/L 230~330		
S25M-QC2235R/L 35	▲			18.2			3.3-4.8	QC22R/L 330~480		

▲Stock available △Make-to-order

Parting and grooving tools code key

● External grooving

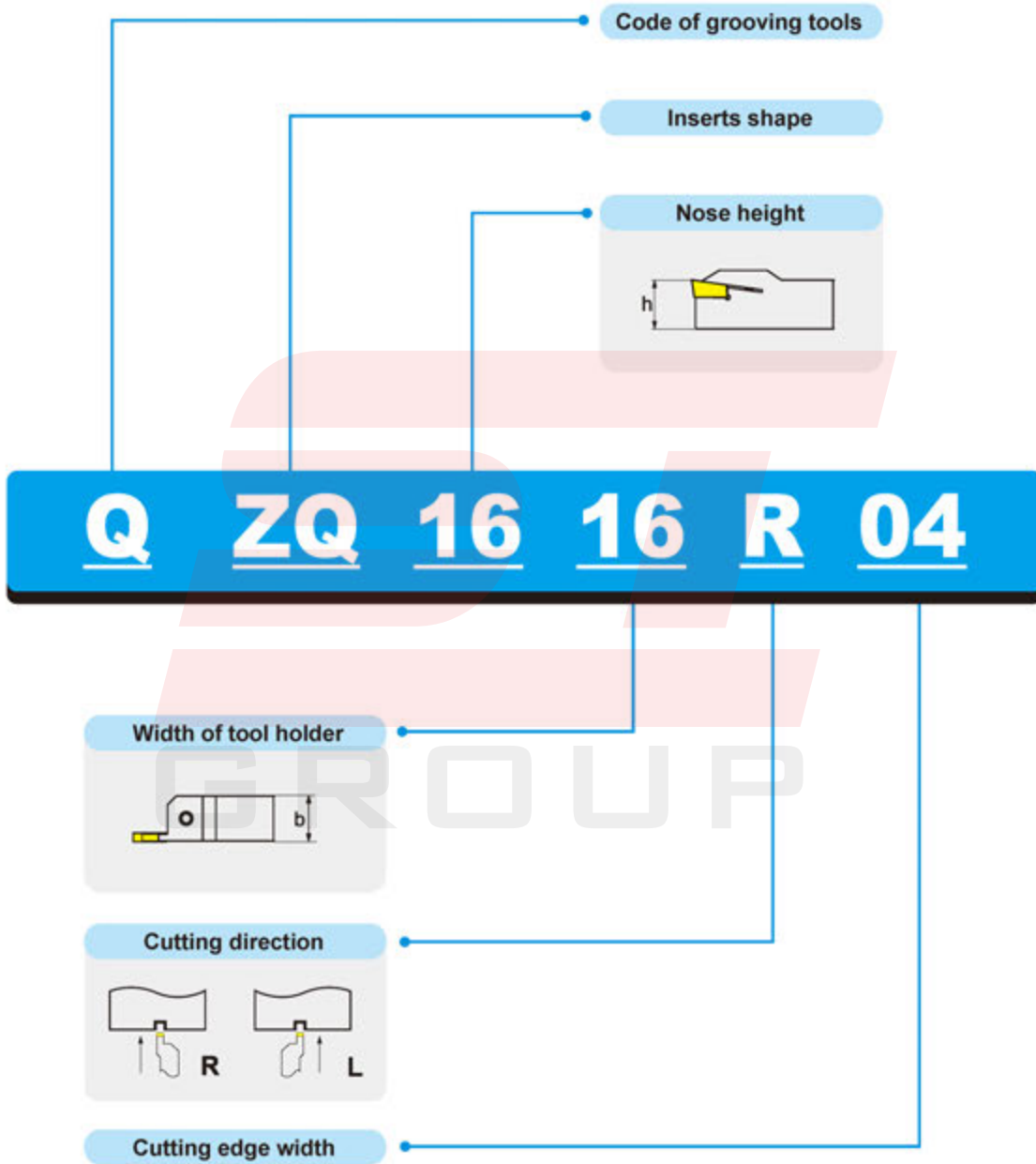

General turning

Parting and grooving

Supplementary series parting and grooving inserts

External parting and grooving tools: QZQ series



R-type shown

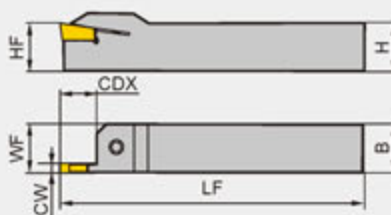

Type	Stock		Basic dimensions(mm)							Applicable inserts	Screw	Wrench	
	R	L	H	HF	B	LF	WF	CW	CDX _{max}				
QZQ	1616R/L03	▲	▲	16	16	16	100	16.4	3	16	ZQMX3N11-IE	GB70-85-M5×16	WH40L
	1616R/L04	▲	▲	16	16	16	100	16.4	4	18	ZQMX4N11-IE		
	2020R/L03	▲	▲	20	20	20	125	20.4	3	20	ZQMX3N11-IE		
	2020R/L04	▲	▲	20	20	20	125	20.4	4	20	ZQMX4N11-IE		
	2525R/L03	▲	▲	25	25	25	150	25.4	3	20	ZQMX3N11-IE		
	2525R/L04	▲	▲	25	25	25	150	25.4	4	20	ZQMX4N11-IE		
	2525R/L05	▲	▲	25	25	25	150	25.4	5	25	ZQMX5N11-IE	GB70-85-M6×20	WH50L
	2525R/L06	▲	▲	25	25	25	150	25.7	6	32	ZQMX6N11-IE		
	3225R/L03	▲	▲	32	32	25	170	25.4	3	25	ZQMX3N11-IE		
	3225R/L04	▲	▲	32	32	25	170	25.4	4	25	ZQMX4N11-IE		
	3225R/L05	▲	▲	32	32	25	170	25.4	5	25	ZQMX5N11-IE		
	3225R/L06	▲	▲	32	32	25	170	25.7	6	35	ZQMX6N11-IE		

▲ Stock available △ Make-to-order

GROUP

General turning

Parting and grooving

Supplementary series parting and grooving inserts

Center height control of parting and grooving tools

- No matter which parting or grooving tools you select, the ideal surface quality is only achieved by ensuring that insert is vertical from the center line of workpiece, which can also effectively reduce vibration during machining.
- The height tolerance between insert edge bottom and the center height of workpiece should be remained in $\pm 0.1\text{mm}$, especially for lever parting and grooving workpieces with small diameter. This can improve tool life, reduce cutting resistant force, and diminish burrs.

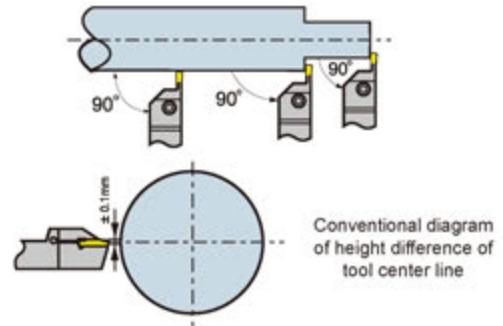

Parting

- When the insert is approaching the center of workpiece, the feed speed should be reduced by 30%, which is good for improving life and surface quality.
- As long as conditions allow, try to shorten the overhang of tools as much as possible to ensure good stability.

External grooving, turning and profiling

- In-feed sequence: When cutting depth $> 0.5\text{mm}$, radial in-feed (Max. cutting depth can be $0.75 \times \text{insert edge width } S$) \rightarrow radial out-feed about 0.1mm \rightarrow axial in-feed \rightarrow flank out-feed \rightarrow axial in-feed \rightarrow radial machining to required depth.
- When finishing, adopt the sequence shown in the diagram. It can reduce vibration caused by the friction between tools and chips.

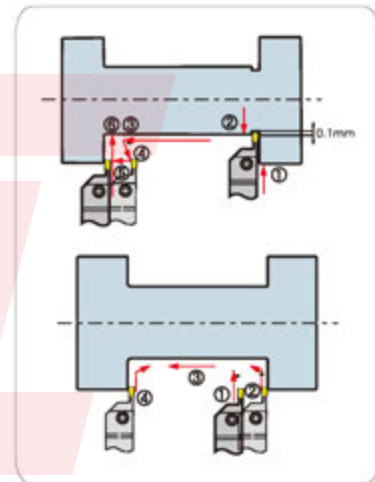

Surface grooving and turning

- Finishing (Multi-slot cutting)
Cut inwards from Max. diameter. Inserts offset to inward flange when retracting, as is shown in diagram (1).
- Recess turning
Axial turning depth should not exceed $0.75 \times S$ (cutting edge width).
If slot width is larger than slot depth, it is recommended to adopt recess turning, as is shown in diagram (2).
If slot depth is larger than slot depth, it is recommended to adopt multi-slot cutting.
- Finish machining
First finish bottom and external diameter fringe, then finish the internal diameter to required size, as is shown in diagram (3).

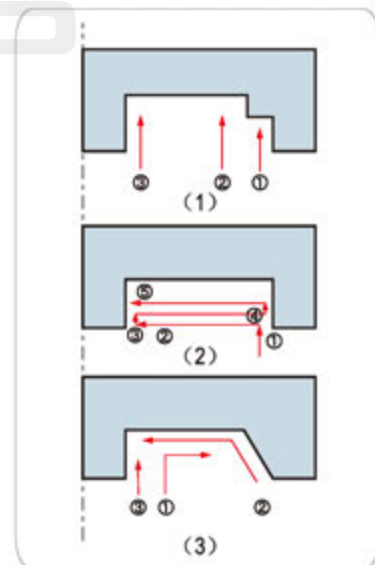

Internal grooving and turning

- To facilitate chip flow, always feed along the direction of moving from the deepest in the hole to outside.

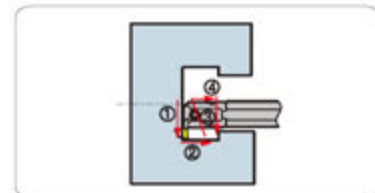



Recommended cutting parameters for parting and grooving

Insert size	Recommended feed rate(mm/r)						
	Insert width(mm)	Parting	Grooving	Grooving(-MM)	Turning	Turning(-MM)	Profiling
2.5		0.05-0.15	0.05-0.15	0.05-0.2	0.05-0.15	0.05-0.2	0.05-0.15
3		0.05-0.15	0.05-0.15	0.05-0.2	0.07-0.15	0.07-0.2	0.1-0.2
4		0.05-0.2	0.05-0.2	0.05-0.25	0.07-0.25	0.07-0.3	0.1-0.2
5		0.07-0.2	0.07-0.22	0.07-0.25	0.1-0.25	0.1-0.3	0.15-0.3
6		0.1-0.3	0.07-0.25	0.07-0.3	0.1-0.3	0.1-0.35	0.15-0.3
8				0.1-0.4		0.15-0.45	

Workpiece material	Hardness	YBG302	YBG202 YBG205	YBG105	YBG212	YBC151	YBC251	YBS103	YD101	YD201	YBG102	YC10	YC40
P Carbon steel	125 < HB < 170	120-260	150-280			140-280	150-280					130-280	110-260
	Low alloy steel	180 < HB < 275	80-175	110-200		100-240	110-200					90-200	70-175
	High alloy steel	180 < HB < 325	80-160	110-190		100-220	110-190					90-190	70-160
	Cast steel	180 < HB < 250	75-140	100-170		80-160	100-170					80-170	60-140
M Ferrite, Martensite	200 < HB < 300	70-170	100-200				100-200					80-200	60-170
	Austenite	180 < HB < 300	80-200	110-220			110-220					90-220	70-200
K Malleable cast iron	130 < HB < 230	100-200	130-220							90-160			
	Grey cast iron	180 < HB < 220	90-170	120-200						80-140			
N Nodular cast iron	160 < HB < 250	80-150	110-180							60-140			
	Al alloy	--							200-400				
S Super alloy	< 400			40-70	20-50			30-80	20-50		30-60		

The cutting parameters recommended are suitable for wet machining.

Advice: For internal machining and endface machining, the cutting speed should be reduced by 30%-40%.

Recommended cutting parameters for QC series shallow groove tools

Processed material	Recommended insert material (cutting speed m/min)		A: Tool feed for grooving(mm/r)				
	PVD Coating		B: Tool feed for horizontal processing(mm/r)				
	YBG202	YBG205	C: Depth of cut for horizontal processing(mm)				
			QC**R/L050-120	QC**R/L125-225	QC**R/L230-325	QC**R/L330-400	QC**R/L400-480
Carbon Steel	80-180	80-180	A: 0.03-0.08	A: 0.04-0.09	A: 0.05-0.1	A: 0.05-0.12	A: 0.05-0.12
			Non-horizontal processing	B: 0.04-0.09	B: 0.05-0.1	B: 0.05-0.1	B: 0.05-1
			Non-horizontal processing	C: 0.3(MAX)	C: 0.5(MAX)	C: 0.5(MAX)	C: 0.8(MAX)
Alloy Steel	80-160	80-160	A: 0.03-0.07	A: 0.04-0.08	A: 0.05-0.09	A: 0.05-0.1	A: 0.05-0.1
			Non-horizontal processing	B: 0.04-0.08	B: 0.05-0.09	B: 0.05-0.1	B: 0.05-1
			Non-horizontal processing	C: 0.3(MAX)	C: 0.5(MAX)	C: 0.5(MAX)	C: 0.5(MAX)
Stainless Steel	60-130	60-130	A: 0.03-0.07	A: 0.04-0.08	A: 0.05-0.09	A: 0.05-0.1	A: 0.05-0.1
			Non-horizontal processing	B: 0.04-0.08	B: 0.05-0.09	B: 0.05-0.1	B: 0.05-1
			Non-horizontal processing	C: 0.3(MAX)	C: 0.5(MAX)	C: 0.5(MAX)	C: 0.5(MAX)

The cutting parameters above are applicable to external grooving. When machining internal grooves, please reduce the cutting speed and feed by 10%.